



**AVAILABLE AT
DIGITAL CINEMA**

CCM7

Welcome to Bowers and Wilkins and the CCM7 Series

Thank you for choosing Bowers & Wilkins. When John Bowers first established our company he did so in the belief that imaginative design, innovative engineering and advanced technology were keys that could unlock the enjoyment of audio in the home. His belief is one that we continue to share and it inspires every product we design.

The CCM7 Series of ceiling mount speakers are designed to offer easy installation and very high quality audio reproduction for discrete custom install applications. This manual describes the installation of CCM7 Series speakers within conventional stud and sheetrock (joist and plasterboard) ceilings.



1. Environmental Information



All Bowers & Wilkins products are designed to comply with international directives on the Restriction of Hazardous Substances (RoHS) in electrical and electronic equipment and the disposal of Waste Electrical and Electronic Equipment (WEEE). These symbols indicate compliance and that the products must be appropriately recycled or processed in accordance with these directives. Consult your local waste disposal authority for guidance.

2. CCM7 Series Basics

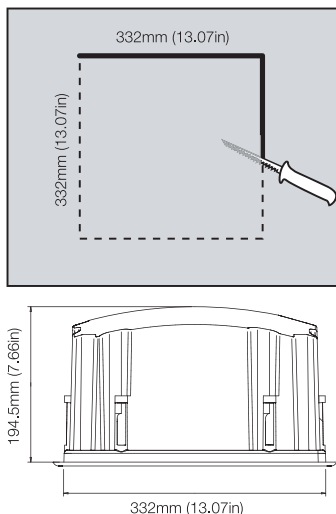

CCM7 Series ceiling mount speakers comprise a baffle carrying the speaker drivers and crossover, an integrated back-box and front flange, and a magnetically secured grille. The back box is connected via external terminals to the speaker cables with the baffle connecting automatically as it is inserted in the back box.

CCM7 Series require a ceiling cut-out aperture of 332mm x 332mm (13.07 in x 13.07 in) and a minimum clear depth of 194.5mm (7.66 in) from the front of the ceiling surface.

Before installing CCM7 Series speakers you should ensure that the ceiling locations chosen are free of obstructions such as pipe work, ducting or wiring that will interfere with the installation. In existing dry-wall construction, use a stud-finding tool to help you map the ceiling construction and a pipe detector to scan the proposed installation locations.

Some stages of the CCM7 Series installation process are best carried out by two people working together.

3. Positioning CCM7 Series Speakers

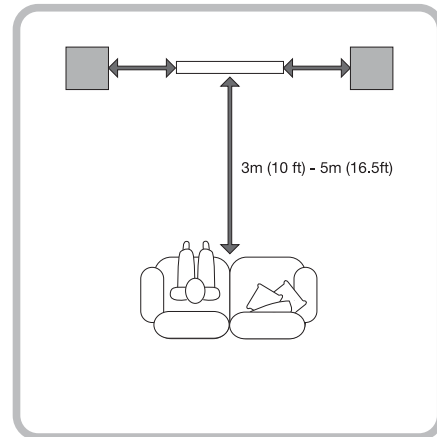

The appropriate position for CCM7 Series speakers within the listening environment will depend on their specific application:

General Background Audio Applications

For applications where single CCM7 Series speakers are required to operate independently to provide background audio, they can be located substantially as installation convenience and architecture dictate. The only acoustic constraint to bear in mind is that corner locations will result in significantly emphasised low frequencies and should be avoided.

Stereo Audio Applications

For applications where a pair of CCM7 Series speakers is to be used for conventional stereo reproduction, they should be located between 3m (10 ft) and 5m (16.5 ft) apart and a similar distance in front of the listening area. Try to avoid corner locations for the speakers and to ensure that acoustic environment around each speaker is similar. The diagram above illustrates this application.

Note: Different acoustic environments might be, for example, a bare wall and a heavily curtained window.

4. Installing CCM7 Series Speakers

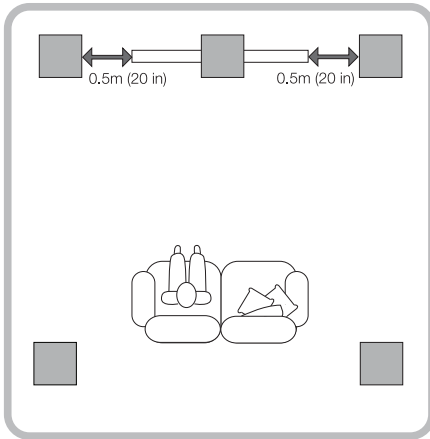

Multi-channel Audio Applications

For applications where multiple CCM7 Series speakers are to be used for multi-channel audio visual systems, the centre speaker should be on the centre line of the screen and the front speakers each laterally within approximately 0.5m (20 in) of the sides of the screen. Surround channel CCM7 Series speakers should be located just behind and either side of the listening position. Try to avoid corner locations for any of the speakers and to ensure that acoustic environment around each front and surround speaker is similar. The diagram above illustrates this application.

Note: Different acoustic environments might be, for example, a bare wall and a heavily curtained window.

In all cases CCM7 Series speakers should be orientated so that their tweeters face generally towards the listening area. Speaker orientation is defined by the installed orientation of the back box. See Section 4.

Note: CCM7 Series speaker dispersion can be adjusted to accommodate use in centre or left, right and surround channel roles. The dispersion is adjusted via a switch on the cross-over. See Paragraph 4.7 for more information.

Note: The nature of the installation of ceiling speakers means that it is sometimes impractical to locate them in the acoustically ideal positions. In these cases they should be located as close as is practical to the ideal positions. Your local Bowers and Wilkins retailer will be able to offer advice if required.

Note: CCM7 Series drive units create stray magnetic fields. We recommend that magnetically sensitive items such as CRT screens and magnetic cards for example, are kept at least 0.5m (20 in) from the speaker. LCD, OLED and plasma screens are not affected by magnetic fields.

To install a CCM7 Series speaker proceed as described in the following paragraphs:

4.1 Using the supplied cut-out template, mark a cut line on the existing ceiling. Check the cut line defines the correct 332mm x 332mm dimensions. Cut along the line with an appropriate tool to create a square aperture in the ceiling.

Note: Ensure that there is enough free space internally adjacent to the aperture for the back box clamps to rotate fully. 20mm (0.79 in) free space is required.

Note: To reduce the possibility of the ceiling buzzing or rattling, adhesive mastic can be applied between the studs and sheetrock in the vicinity of the speaker aperture.

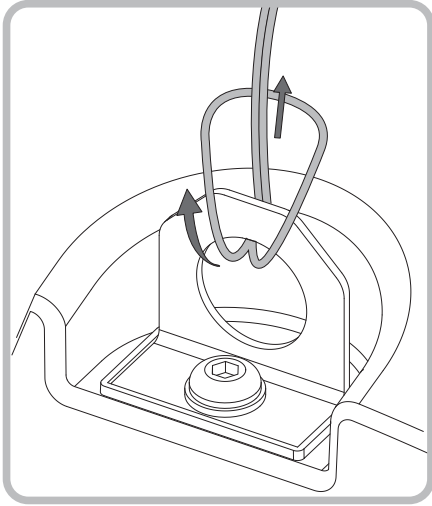

4.2 If speaker cable is already present in the ceiling space, pull the cable down through the aperture. If speaker cables are not already installed this should be done at this stage. It is likely that you will need to gain access through the floor above to route the cables through the ceiling space.

Leave enough spare cable through the aperture to ease connection to the speaker back box, but not so much that it is likely to buzz or rattle when pushed back up into the ceiling space. Approximately 1.0m (40 in) is appropriate.

Note: Always use high quality, low resistance speaker cable. Low resistance is especially important if the length of cable from amplifier to speaker exceeds 5.0m. Your local Bowers and Wilkins retailer will be able to offer advice on speaker cable selection if required.

4.3 CCM7 Series speaker back boxes are fitted with a safety hook feature that enables a safety chain or cable to be attached and then secured to a structural element within the ceiling – typically a stud (joist). We strongly recommend the safety hook feature is used. The diagram above illustrates the use of the safety hook.

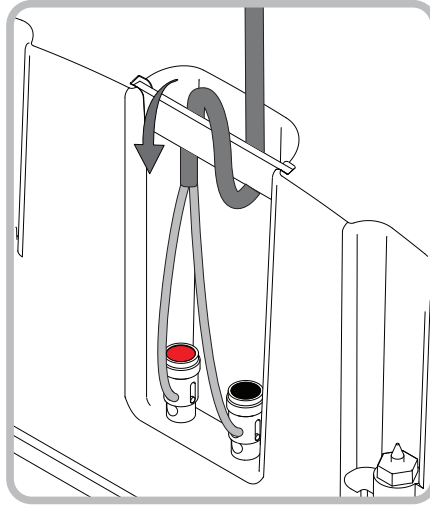

4.4 Now connect the speaker cable to the spring terminals on the side of the back box, first looping the cable around the strain relief bar. A second person will be required to hold the back box while the cable is connected. The diagram above illustrates the cable connection.

Ensure that the speaker connection polarity is correct: the cable connected to the positive terminal on the amplifier should be connected to the red spring terminal on the back box. Similarly, the cable connected to the negative terminal on the amplifier should be connected to the black spring terminal on the back box.

Note: If an amplifier is already connected to the cable it should be switched off while connections are being made to the back box.

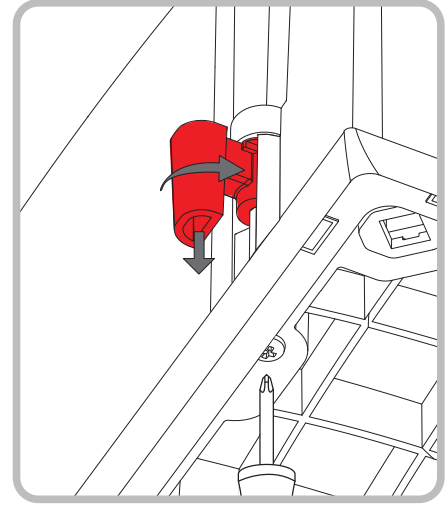

4.5 With the back box connected it may be lifted up into the ceiling aperture. Correct back box orientation must be established at this stage: the red arrow on the back box flange should be pointing towards the listening area.

Ensure that the clamps are retracted so that they will pass through the aperture then lift the back box up so that the flange is flush on the ceiling. Take care that the cable is not trapped. One person should hold the back box in place while a second tightens the eight clamp screws. The diagram above illustrates insertion of the back box.

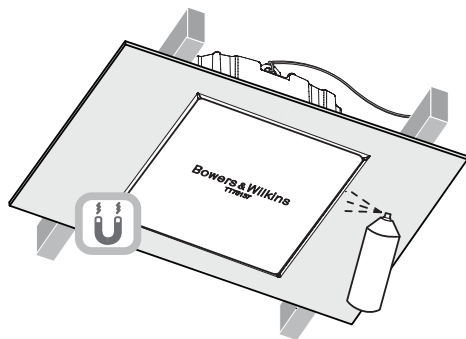

4.6 If the back box flange is to be painted it should be done at this stage. Any conventional, domestic paint may be applied by brushing, rolling or spraying. Use the supplied paint mask to avoid getting paint in the back box cavity. Painting without using the paint mask risks contamination of the internal connection terminals or the grille attachment magnets. The diagram above illustrates painting using the paint mask.

Note: If the grille is to be sprayed this should be done "off-line" before it is fitted.

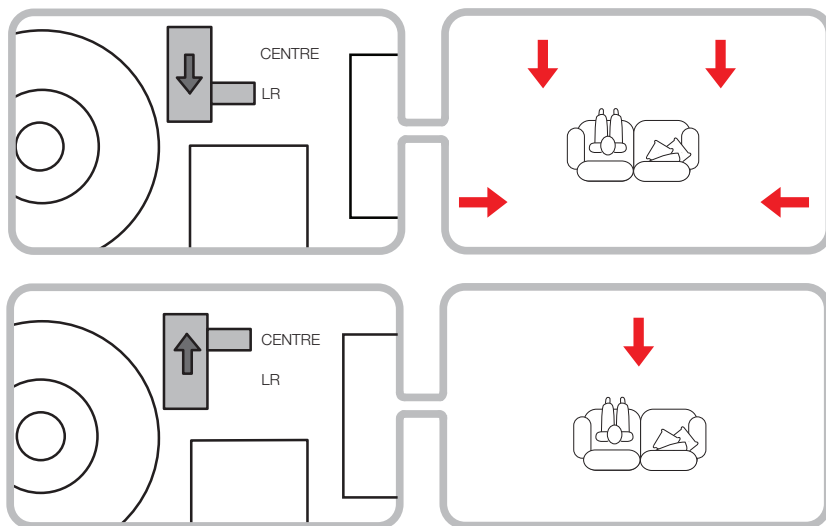

4.7 If the speaker is to be used in the centre channel role in a multi-channel system, select the centre position on the cross-over mounted dispersion switch. In all other applications select the left/right position on the switch. The diagram above illustrates the dispersion switch.

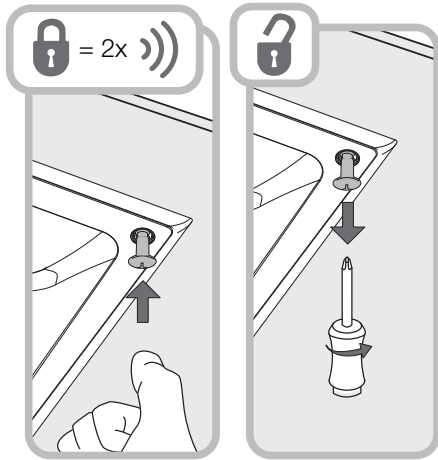

IMPORTANT: Follow installation process shown in 4.8a for all serial numbers equal to or lower than the following:

CCM7.5 – 1503 0008309
 CCM7.4 – 1503 0005294
 CCM7.3 – 1502 0006048

4.8a The baffle can now be lifted up into the back box. Ensure that the connector on the baffle is orientated correctly with the connector inside the back box. The baffle is held in the back box by four push-lock fasteners. Push-lock fasteners are secured by pushing the head inwards with your thumb: as they secure, the fasteners will click. Do not use a screwdriver to secure the push-lock fasteners.

With one person holding the baffle in place, a second person can push and secure the four push-lock fasteners. The fasteners will click two times. The baffle will then be secure in the back box. The diagram above illustrates inserting the baffle and securing the push-lock fasteners.

Note: Push-lock fasteners are unsecured by turning them 45° using a manual screwdriver. Ensure a second person is supporting the baffle when the push-lock fasteners are unsecured so that the baffle does not fall.

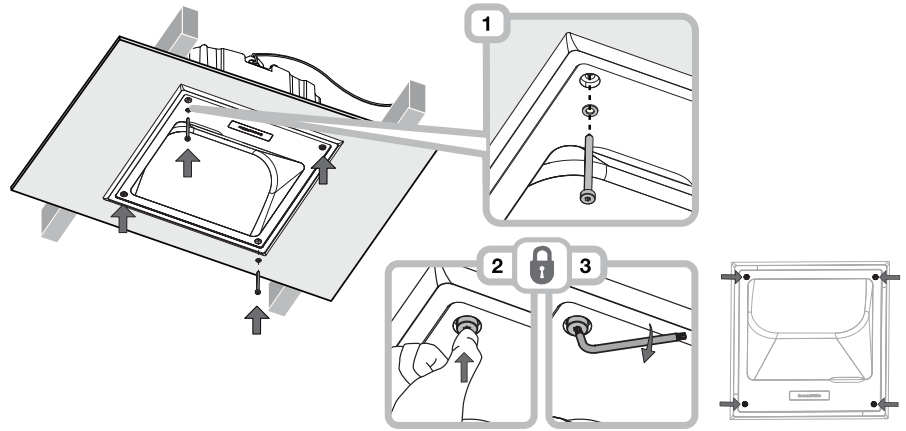

IMPORTANT: Follow installation process shown in 4.8b for all serial numbers equal to or higher than the following:

CCM7.5 – 1503 0008310
 CCM7.4 – 1503 0005295
 CCM7.3 – 1502 0006049

4.8b The baffle can now be lifted up into the back box. Ensure that the connector on the baffle is orientated correctly with the connector inside the back box. The baffle is held in the back box by four fasteners. Two are retained in the baffle and a further two are contained in the accessories supplied with the product.

Offer the baffle to the back box and push the two retained fasteners into their coordinated locking mechanism, as the bolts are pushed into the fasteners they will click repeatedly. With one person holding the baffle in place, a second person can insert the remain two washers and bolts, pushing them into position – either using a thumb or supplied key. All four fasteners should then be locked in place by using the supplied key and turning the bolts in a clockwise direction. The diagram above illustrates inserting the baffle and securing the fasteners.

Note: The fasteners are unsecured by using the supplied key to turn the bolts in an anticlockwise direction. Ensure a second person is supporting the baffle when the push-lock fasteners are unsecured so that the baffle does not fall.

4.9 The grille can now be fitted to the baffle. It is held in place magnetically so simply needs to be aligned with the groove in the back box flange where it will click into place. The diagram above illustrates fitting the grille.

The CCM7 Series speaker is now installed and ready for use.

Bowers & Wilkins

B&W Group Ltd
Dale Road
Worthing West Sussex
BN11 2BH England

T +44 (0) 1903 221 800
F +44 (0) 1903 221 801
info@bwgroup.com
www.bowers-wilkins.com

B&W Group (UK Sales)
T +44 (0) 1903 221 500
E uksales@bwgroup.com

B&W Group North America
T +1 978 664 2870
E marketing@bwgroupusa.com

B&W Group Asia Ltd
T +852 3 472 9300
E info@bwgroup.hk

Copyright © B&W Group Ltd. E&OE