

# D.

DEFINITIVE TECHNOLOGY

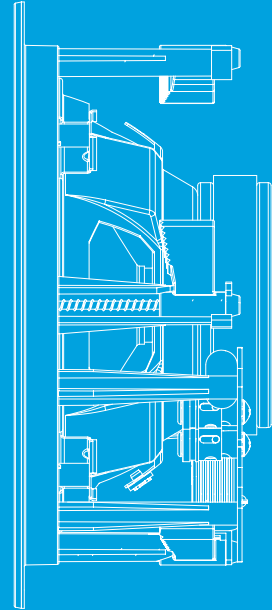
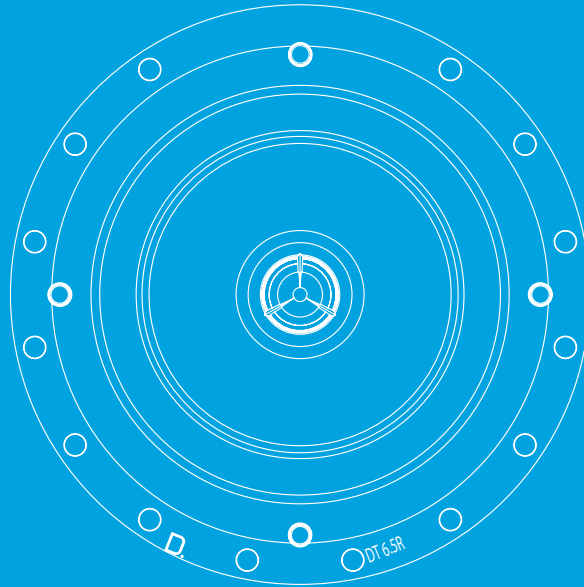

DIGITAL  
CINEMA

AVAILABLE AT  
DIGITAL CINEMA

## DT Series

### In-ceiling Installation Guide

Models: DT6.5R, DT6.5STR, DT8R, DT6.5LCR, DT8LCR

## Thank You

Thank you for choosing Definitive Technology DT Series In-Wall loud-speakers. The DT Series offers excellent sound quality from speakers that virtually disappear when installed in a wall or ceiling. To ensure you experience the finest performance possible, please take some time to fully read this owner's manual and familiarize yourself with the proper installation and setup procedures.

### Unpacking Your DT Series Loudspeakers

#### **Please inspect for shipping damage**

Each loudspeaker leaves our plant in perfect condition. Any visible or concealed damage most likely occurred in handling after the loudspeaker left our plant and should be reported at once to your Definitive dealer or the delivery company that delivered your loudspeaker. Please unpack your system carefully. Save all cartons and packing materials should you move or need to ship your system. Your loudspeakers' serial numbers can be found on the back of each loudspeaker and on the carton; record those numbers in this manual and save it for future reference should your speaker need service. For your best protection, register your DT Series products on-line at <http://registration.definitivetech.com>.

#### **Painting DT Series Speakers**

Your DT Series speakers may be painted to match the color of the wall or ceiling in which they are installed. Failure to follow these painting instructions may result in seriously degraded sound quality. It is your responsibility to make sure your painting contractor sees and follows these instructions.

#### **1. DO NOT PAINT THE GRILLE WITH A BRUSH OR ROLLER**

they will clog the fine mesh of the grille and cloth scrim and result in poor sound quality.

2. Remove the grille from the speaker and place it on a drop cloth, newspaper or plastic sheet.

3. The grille **MUST** be spray painted with one of the following:

- Spray paint that closely matches the desired finish/color
- A custom spray bomb, color matched to your paint finish
- Indoor latex paint using a spray gun (paint must be diluted to the paint manufacturer's specifications)

4. Removing the backing cloth (scrim) is not required.

5. Paint should be applied in a series of thin coats sprayed at approximately 60 degrees from the grille surface.

6. Allow each coat to fully cure before applying additional coats.

7. To ensure the paint is applied evenly, each coat should be sprayed on from at least 4 Different Directions to the grille.

(N, S, E & W) This will ensure even coverage on the grille.

8. Once the grille has been painted and the paint has fully cured, you may use a brush, or small roller to touch-up the outer edge of the grille frame; Be very careful not to get any additional paint on the grille's mesh surface.

**Note:** Sherwin Williams Automotive Finishes Stores will custom make an aerosol paint to match any sample that is easier to apply.

Store Locator at <http://www.sherwin-automotive.com/collision-repair/branches-where-to-buy/store-locator/>

### Optional Fire-Rated Enclosures

Definitive DT Series speakers have been designed to meet UL 1480 and 2043 standards when used with the appropriate optional Definitive fire-rated enclosures. All plastic parts used in the speakers are V0 flame rated as per UL 94. While these enclosures are necessary in most countries for commercial and multi-family installations, residential customers may want to use them for added safety and/or to reduce the sound from "leaking" into adjacent rooms.

### Placement Options

Definitive Technology DT Series Loudspeakers give you nearly endless placement options. But remember that placement choice for your in-wall speakers bears careful consideration, as installation requires that you cut a hole in your wall or ceiling! It's best to keep the speakers at least 2 feet (60 cm) from side walls [Figure 1]. When using DT Series models in home theater applications, follow the guidelines [illustrated in Figures 2, 3 and 4]. Definitive DT Series Loudspeakers have aimable tweeters that allow you to focus their sound toward or away from your listening area, depending on the application. Whenever possible take advantage of attic and crawl spaces, as it's much easier to run cables through them than through walls.

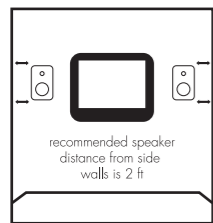

Figure 1

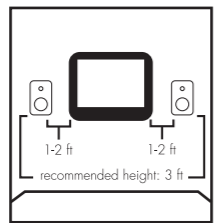

Figure 2

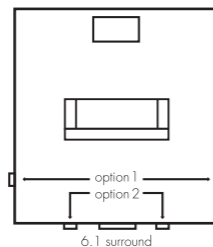

Figure 3

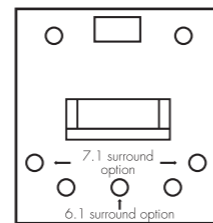

Figure 4

### Aiming the Tweeter

A tweeter aimed toward your listening position improves imaging and detail. To aim the tweeter, first install the speaker in the desired location. Rotate the tweeter so that the arrow on the tweeter faceplate is pointing in the direction you wish to aim the tweeter [Figure 5] then gently push the tweeter in that direction [Figure 6]. When using DT Series speakers as fronts in a home theater setup or as stereo speakers in a distributed audio system, aim the tweeter toward the main listening position. As rear/surround speakers installed in walls or ceilings, aim the tweeter toward the nearest reflecting surface (an adjacent wall or ceiling) for a more diffuse sound field (For more direct sound, aim the tweeters at your listening position).

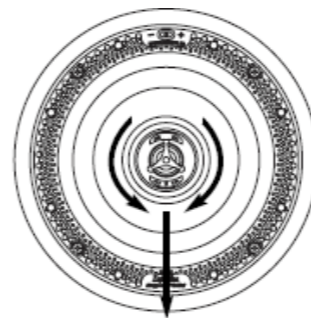

Figure 5  
Point tweeter in desired direction by turning the tweeter assembly.



Figure 6a  
Push gently in direction of arrow to set angle.

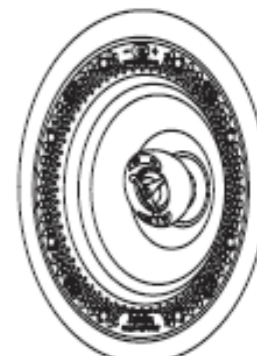
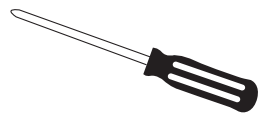

Figure 6b

## Installation Cautions

Installing DT Series speakers requires skill in using tools such as a drill, screwdriver, saws and power tools. Installation also entails running wires through walls. You should have a thorough understanding of local building and fire codes and a familiarity with the area behind the wall or ceiling into which you plan to install your speakers. When cutting holes and running wires through walls/ceilings you run the risk of cutting electrical wires or water pipes, thereby causing safety hazards and property damage. If you're in any doubt that you possess the necessary skills or tools to install these speakers, contact your Definitive Technology dealer, general contractor or a professional installer.

## Required Tools



Phillips head screwdriver

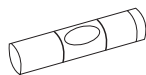

Bubble level

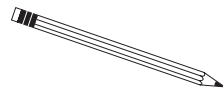

Pencil for marking the location of installation

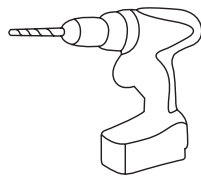

Power drill with appropriate bit (optional, for starting wall cut)

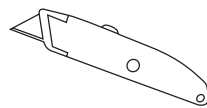

Keyhole saw, utility knife or material appropriate incising implement for cutting drywall or other wall material

## Installation Procedure

- You must first install speaker wires that meet appropriate building and fire codes before installing the speakers. Use at least 18 gauge wire or heavier to ensure optimum sound quality.
- Make sure the material into which you plan to mount the speakers (plaster, drywall, paneling, stone, etc.) can support the weight of the speakers.
- Make sure the locations you select do not conceal studs, electrical wiring or plumbing. Prior to installation, hold the speaker with grille on in your chosen location to make sure it safely clears obstacles such as studs, corners, beams, lighting fixtures and door/window frames. Your cutout must be at least 2" (50 mm) from adjoining walls or ceiling, internal studs or plumbing.
- Using the supplied template, trace the installation location with a pencil. You can do this by holding the template in your preferred location and tracing around it. In the case of the rectangular models (DT6.5LCR and DT8LCR) use a bubble level to square and level the template. [Figures 8 & 9]
- Carefully cut the hole with the appropriate cutting tool for your wall or ceiling material. Start the hole by drilling a hole on the inside of the tracing (with the drill bit just inside the line). Use this hole to insert the saw or knife and begin cutting. [Figure 10]

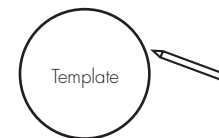

Figure 8

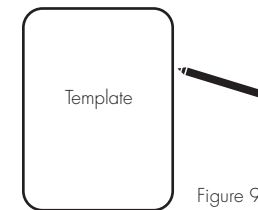

Figure 9

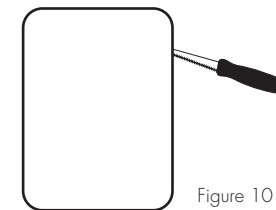

Figure 10

- Once you have cut the hole, pull the speaker wire out of the hole and connect the speaker. Strip 1/2" inch (12 mm) of insulation from each of the two conductors of the wire to expose the bare metal and twist each of the conductors into a single unfrayed strand. Note that one of the terminals on the rear of each speaker is marked red (+) and the other black (-). Make certain that you connect the wire from the red terminal (+) of your amplifier or receiver to the red terminal (+) on your speaker and the wire from the black terminal (-) of your amplifier or receiver to the black terminal (-) on your speaker. Most wire has some indicator (such as color-coding, ribbing or writing) on one of the two conductors to help you maintain consistency [Figure 11a]. In the case of the DT 6.5STR single speaker stereo model, both left and right channel speaker wires are connected to the speaker [Figure 11b].

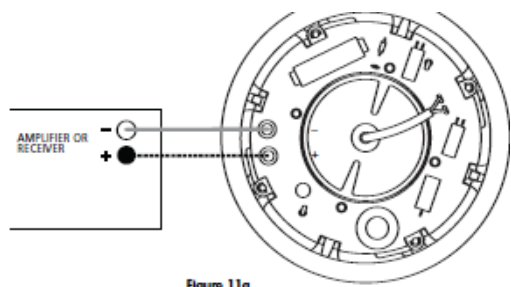

Figure 11a

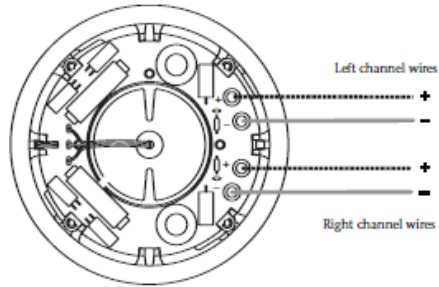

Figure 11b

- Push down on the top of the terminal to reveal the wire hole in the side of the terminal post and insert the wire into the hole [Figure 12]. Release the pressure on the terminal to secure the wire.



Figure 12

- Loosen the rotating lock arms by turning the lock arm screws on the front of the speaker counter clockwise 1/2 to 1 turn, just enough to allow the lock arm to move freely. [Figure 13]. Make sure that the rotating lock arms are flipped inwards [Figure 14] so that your speaker fits into your cutout.

Lock arm screws.  
Turn counter clockwise  
to loosen.

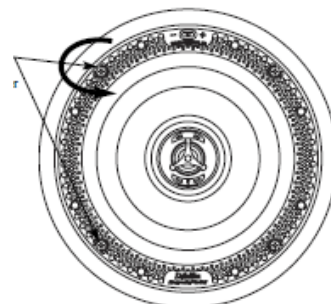

Figure 13

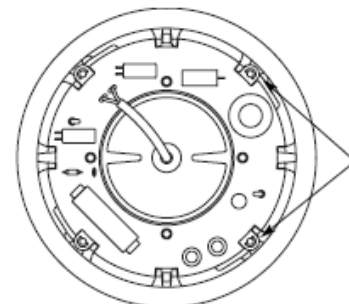

Figure 14

- Place the speaker carefully into the cutout. If you have a level, use it to help you correctly align rectangular speaker models. Tighten the lock arm screws with a screwdriver [Figure 15]. This will rotate the lock arms [Figure 16] and secure the speaker to the wall/ceiling.

**Do not over-tighten the lock arm screws.** If you are using a powered screwdriver or drill, set the torque to a value of 7 in. – lb. (8dN – m). Install the grille on the speaker frame. Powerful magnets hold the grille in place.

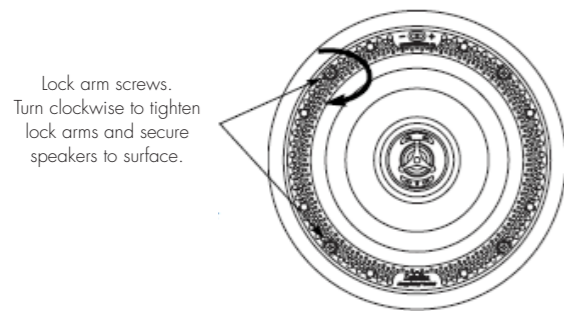

Figure 15

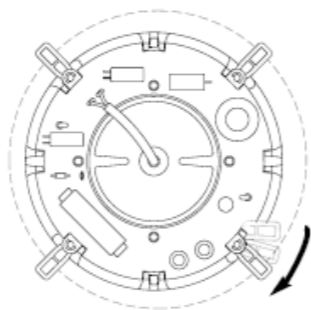

Figure 16

### Safety First

When installing your Di Series In-Wall Loudspeakers, be aware of the weight of your particular model and the sturdiness of the material into which you are installing the speaker. Also be aware of any concealed studs, electrical wiring or plumbing in the wall or ceiling into which you are installing the speakers. If you are not sure of a safe way to install these speakers, consult a professional installer, your authorized Definitive Technology dealer, or a building contractor.

### Technical Assistance

It is our pleasure to offer assistance if you have any questions regarding your Definitive Technology loudspeakers. Please contact your nearest Definitive Technology dealer or call us directly at (800) 228-7148 (US & Canada), 01 (410) 363-7148 (international) or e-mail [info@definitivetech.com](mailto:info@definitivetech.com).

### Service

Service work on your Definitive loudspeakers will normally be performed by your local Definitive Technology dealer. If your dealer is unable or unwilling to perform service contact us for alternative options. Please note that the address given in this manual is the address of our offices only. Under no circumstances should loudspeakers be shipped to our offices or returned without contacting us first and obtaining return authorization.

## Definitive Technology Offices

11433 Cronridge Drive  
 Owings Mills, Maryland 21117  
 Phone: (800) 228-7148 (US & Canada),  
 01 (410) 363-7148 (all other countries)

### WARNING: LISTEN CAREFULLY

Definitive Technology loudspeakers and subwoofers are capable of playing at extremely high volume levels, which could cause serious or permanent hearing damage. Definitive Technology accepts no liability for hearing loss, bodily injury or property damage resulting from the misuse of its products. You should limit prolonged exposure to volumes that exceed 85 decibels (dB). For more about safe volume levels refer to the Occupational Health and Safety Administration (OSHA) guidelines at: [www.osha.gov](http://www.osha.gov)

| Specifications              | DT6.5R  | DT6.5STR                                  | DT8R              | DT6.5LCR            | DT8LCR              |
|-----------------------------|---|---|-------------------|---------------------|---------------------|
| Grille Diameter             | 8-5/16" (21.11cm)                             | 8-5/16" (21.11cm)                         | 9.75" (24.76cm)   |                     |                     |
| Grille Length               |   |   |                   | 13-13/16" (35.08cm) | 13-13/16" (35.08cm) |
| Grille Width                |   |   |                   | 8-1/4" (20.96cm)    | 9-7/8" (25.08cm)    |
| Optional Sq. Grille         |   |   |                   |                     |                     |
| Cutout Diameter             | 7-1/4" (18.41cm)                              | 7-1/4" (18.41cm)                          | 8-3/4" (22.23cm)  |                     |                     |
| Cutout Width                |   |   |                   | 7-1/4" (18.42cm)    | 8-3/4" (22.2cm)     |
| Cutout Length               |   |   |                   | 12-3/4" (32.3cm)    | 12-3/4" (32.3cm)    |
| Total Depth*                | 3-3/8" (8.57cm)                               | 3-9/16" (9.05cm)                          | 3-13/16" (9.68cm) | 3-5/16" (8.41cm)    | 3-3/4" (9.52cm)     |
| Mounting Depth In-Wall**    | 2-7/8" (7.30cm)                               | 3-1/16" (7.78cm)                          | 3-5/16" (8.41cm)  | 2-13/16" (7.14cm)   | 3-1/4" (8.26cm)     |
| Woofer                      | 6-1/2" (16.5cm)                               | 6-1/2" (16.5cm)                           | 8" (20.3cm)       | 6-1/2" (16.5cm)     | 8" (20.3cm)         |
| Tweeter                     | 1" (25mm)                                     | Two 3/4" (19mm)                           | 1" (25mm)         | 1" (25mm)           | 1" (25mm)           |
| Product Weight              | TBD   | TBD                                       | TBD               | TBD                 | TBD                 |
| Frequency Response          | 28 Hz – 30 kHz                                | 27 Hz – 30 kHz                            | 27 Hz – 30 kHz    | 28 Hz – 30 kHz      | 27 Hz – 30 kHz      |
| A/V Crossover Setting       | Small (60Hz)                                  | Small (60Hz)                              | Small (60Hz)      | Small (60Hz)        | Small (60Hz)        |
| Sensitivity                 | 89dB  | 89dB                                      | 89dB              | 89dB                | 89dB                |
| Impedance                   | All models are compatible with 8 Ohm outputs. |   |                   |                     |                     |
| Recommended Power (Min/Max) | 10/200w/Ch                                    | 10/100w/Ch Stereo;<br>10/200w/Ch Surround | 10/225w/Ch        | 10/200w/Ch          | 10/225w/Ch          |

\* From back of mounting flange to deepest part of product  
 \*\* Total depth when product installed in 1/2" (12.7mm) thick material

## LIMITED USA WARRANTY

### 5-YEARS FOR DRIVERS AND CABINETS, 3-YEARS FOR ELECTRONIC COMPONENTS

DEI Sales Co., dba Definitive Technology (herein "Definitive") warrants to the original retail purchaser only that this Definitive loudspeaker product (the "Product") will be free from defects in material and workmanship for a period of five (5) years covering the drivers and cabinets, and three (3) years for the electronic components from the date of the original purchase from a Definitive Authorized Dealer. If the Product is defective in material or workmanship, Definitive or its Authorized Dealer will, at its option, repair or replace the warranted product at no additional charge, except as set forth below. All replaced parts and Product(s) become the property of Definitive. Product that is repaired or replaced under this warranty will be returned to you, within a reasonable time, freight collect. This warranty is non-transferrable and is automatically void if the original purchaser sells or otherwise transfers the Product to any other party. This Warranty does not include service or parts to repair damage caused by accident, misuse, abuse, negligence, inadequate packing or shipping procedures, commercial use voltage in excess of the rated maximum of the unit, cosmetic appearance of cabinetry not directly attributable to defects in material or workmanship. This warranty does not cover the elimination of externally generated static or noise, or the correction of antenna problems or weak reception. This warranty does not cover labor costs or damage to the product caused by installation or removal of the Product. Definitive Technology makes no warranty with respect to its products purchased from dealers or outlets other than Definitive Technology Authorized Dealer.

### THE WARRANTY IS AUTOMATICALLY VOID IF:

- 1) The product has been damaged, altered in any way, mishandled during transportation, or tampered with.
- 2) The product is damaged due to accident, fire, flood, unreasonable use, misuse, abuse, customer applied cleaners, failure to observe manufacturers warnings, neglect or related events.
- 3) Repair or modification of the Product has not been made or authorized by Definitive Technology.
- 4) The product has been improperly installed or used.  
Product must be returned (insured and prepaid), together with the original dated proof of purchase to the Authorized Dealer from whom the Product was purchased, or to the nearest Definitive factory service center. Product must be shipped in the original shipping container or its equivalent. Definitive is not responsible or liable for loss or damage to product in transit.

THIS LIMITED WARRANTY IS THE ONLY EXPRESS WARRANTY THAT APPLIES TO YOUR PRODUCT. DEFINITIVE NEITHER ASSUMES NOR AUTHORIZES ANY PERSON OR ENTITY TO ASSUME FOR IT ANY OTHER OBLIGATION OR LIABILITY IN CONNECTION WITH YOUR PRODUCT OR THIS WARRANTY. ALL OTHER WARRANTIES, INCLUDING BUT NOT LIMITED TO EXPRESS, IMPLIED, WARRANTY OF MERCHANTABILITY OR FITNESS FOR A PARTICULAR PURPOSE, ARE EXPRESSLY EXCLUDED AND DISCLAIMED TO THE MAXIMUM EXTENT ALLOWED BY LAW. ALL IMPLIED WARRANTIES ON PRODUCT ARE LIMITED TO THE DURATION OF THIS EXPRESSED WARRANTY. DEFINITIVE HAS NO LIABILITY FOR ACTS OF THIRD PARTIES. DEFINITIVE'S LIABILITY, WHETHER BASED ON CONTRACT, TORT, STRICT LIABILITY, OR ANY OTHER THEORY, SHALL NOT EXCEED THE PURCHASE PRICE OF THE PRODUCT FOR WHICH A CLAIM HAS BEEN MADE. UNDER NO CIRCUMSTANCE WILL DEFINITIVE BEAR ANY LIABILITY FOR INCIDENTAL, CONSEQUENTIAL OR SPECIAL DAMAGES. THE CONSUMER AGREES AND CONSENTS THAT ALL DISPUTES BETWEEN THE CONSUMER AND DEFINITIVE SHALL BE RESOLVED IN ACCORDANCE WITH CALIFORNIA LAWS IN SAN DIEGO COUNTY, CALIFORNIA. DEFINITIVE RESERVES THE RIGHT TO MODIFY THIS WARRANTY STATEMENT AT ANY TIME.

Some states do not allow the exclusion or limitation of consequential or incidental damages, or implied warranties, so the above limitations may not apply to you. This warranty gives you specific legal rights, and you may also have other rights which vary from state to state.





11433 Cronridge Drive  
Owings Mills, Maryland 21117  
800-228-7148  
[www.definitivetech.com](http://www.definitivetech.com)