

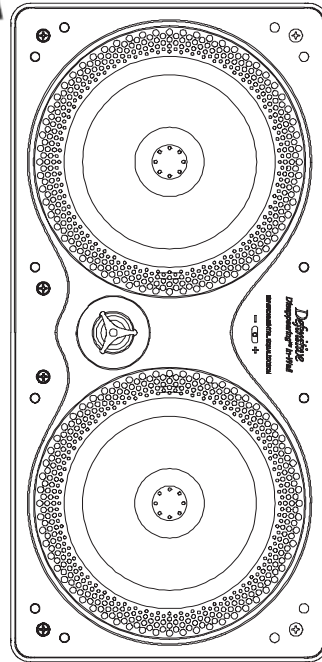

AVAILABLE AT  
DIGITAL CINEMA

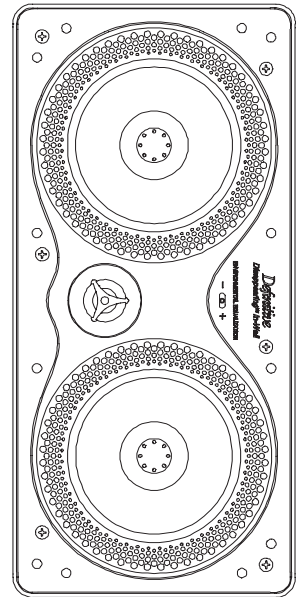

6.5LCR



5.5LCR

Specifications

	5.5LCR	6.5LCR
Grille Length	15-5/16" (38.9cm)	17-1/8" (43.5cm)
Grille Width	7-3/8" (18.7cm)	8-5/16" (21.0cm)
Cutout Width	14-3/8" (36.4cm)	16-3/16" (41.0cm)
Cutout Length	6-7/16" (16.4cm)	7-5/16" (18.6cm)
Total Depth *	3-5/8" (9.3cm)	3-5/8" (9.3cm)
Mounting Depth In-Wall **	3-1/8" (7.27cm)	3-1/8" (7.27cm)
Woofer	2@5-1/4" (13.3cm)	2@6-1/2" (16.5cm)
Tweeter	1@1"(25mm)	1@1"(25mm)
Product Weight	8 lbs (3.6Kg)	8.5 lbs (3.9Kg)
Frequency Response	28Hz - 30kHz	26Hz - 30kHz
Sensitivity	89dB	90dB
Impedance	4-8 Ohms	4-8 Ohms
Recommended Amp Power	10 -250 WPC	10 - 275 WPC

\* From back of mounting flange to deepest part of product

\*\* Total depth when product installed in 1/2" (12.7 mm) thick material

*Definitive Technology*<sup>®</sup>  
The Leader in High-Performance Loudspeakers<sup>®</sup>

Thank You

Thank you for choosing Definitive Technology Disappearing In-Wall Loudspeakers. The DI Series products offer extraordinary sound quality from speakers that are barely visible when installed in a wall or ceiling. Our engineers spent many years developing this product. In order to ensure that you experience the finest performance possible, we encourage you to take a moment to fully read this owner's manual and familiarize yourself with the proper installation and set-up procedures for your DI Series speaker.

Unpacking Your Disappearing In-Wall Speakers

Please Inspect For Shipping Damage

Each loudspeaker leaves our plant in perfect condition. Any visible or concealed damage most likely occurred in handling after it left our plant and should be reported at once to your Definitive dealer or the delivery company that delivered your loudspeaker. Please unpack your system carefully. Save all cartons and packing materials in case you move or need to ship your system. Record the serial number found on the back of the speakers and on the carton in this manual and save it for future reference should your speaker need service. For your best protection, register your DI Series products on-line at <http://www.definitivetech.com/Registration/>.

## Painting DI LCR Speakers

Your DI Series speakers may be painted to match the color of the wall or ceiling in which they are installed. **Failure to follow the following painting instructions may result in seriously degraded sound quality.** It is your responsibility to make sure your painting contractor sees and follows these instructions.

1. DO NOT PAINT THE GRILLE WITH A BRUSH OR ROLLER — they will clog the fine mesh of the grille and cloth scrim and result in poor sound quality.
2. Remove the grille from the speaker and place it on a drop cloth, newspaper or plastic sheet.
3. The grille MUST be spray painted with one of the following:
  - Spray paint that closely matches the desired finish/color
  - A custom spray bomb color matched to your paint finish
  - Indoor latex paint using a spray gun (paint must be diluted to the paint manufacturer's specifications)
4. Do not remove the backing cloth (scrim).
5. Paint should be applied in a series of thin coats sprayed at approximately 60 degrees from the grille surface, allowing each coat to fully cure before applying additional coats.
6. To ensure that the paint distribution is evenly applied, each coat should be applied from at least 4 different directions to the grille. (N, S, E & W) This will ensure an even coverage on the grille.
7. Once the grille has been painted and the paint has fully cured, you may use a brush or small roller to touch-up the outer edge of the grille frame — being VERY careful not to get any additional paint on the grille mesh surface.

## Placement Options

Definitive Technology DI Series Loudspeakers give you nearly endless placement options. But remember that placement choice for your in-wall speakers bears careful consideration, as installation requires that you cut a hole in your wall or ceiling. It is best to keep the speakers at least 2 feet (60 cm) from side walls [Figure 1]. When using DI Series models in home theater applications follow the guidelines illustrated in Figures 2 and 3. Orient the left and right speakers so that the tweeters are on the outside edge as shown in Figure 2. Definitive DI Series In-Wall Loudspeakers have aimable tweeters that allow you to focus their sound toward or away from your listening area depending on the application (see page 6).

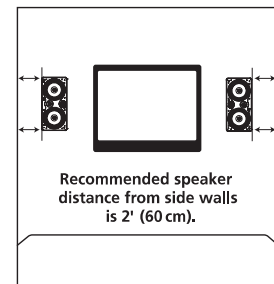

Figure 1

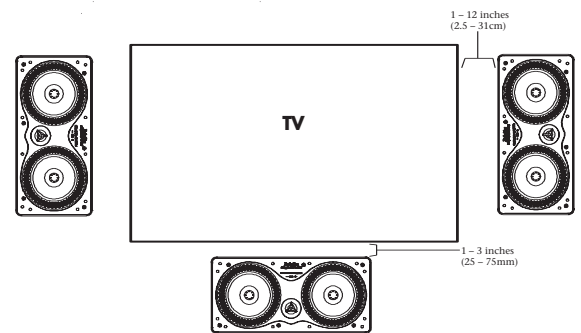

Figure 2

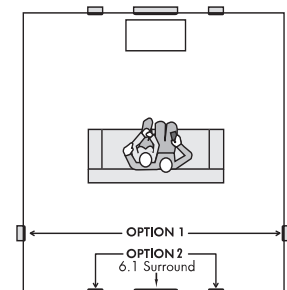

Figure 3

## Installation

### Installation Cautions

Installation of Disappearing Series Loudspeakers requires skills in using tools such as a drill, screwdriver, saws and power tools. Installation also entails running wires through walls. You should have a thorough understanding of local building and fire codes and a familiarity with the area behind the wall or ceiling into which you plan to install your speakers. When cutting holes in and running wires through walls/ceilings, you run the risk of cutting electrical wires or water pipes, thereby causing safety hazards and property damage. If you are in any doubt that you possess the necessary skills or tools, contact your Definitive Technology dealer, general contractor or a professional installer.

### Required Tools

- Pencil for marking the location of installation.
- Bubble level
- Keyhole saw, utility knife or material- appropriate incising implement for cutting drywall or other wall material.
- Phillips head screwdriver.
- Power drill with appropriate bit (optional, for starting wall cut).

### Installation Procedure

You must first install speaker wires that meet appropriate building and fire codes before installing the speakers. Use at least 18 gauge wire or heavier to ensure optimum sound quality.

- Make sure the material into which you plan to mount the speakers (plaster, drywall, paneling, stone, etc.) can support the weight of the speakers (see specification page for the weight of your model).
- Make sure the locations you select do not conceal studs, electrical wiring or plumbing. Prior to installation, hold the speaker with grille on in your chosen location to make sure it safely clears obstacles such as studs, corners, beams, lighting fixtures and door/window frames. Your cutout must be at least 2" (50 mm) from adjoining walls or ceiling, internal studs or plumbing.
- NOTE: The DI 5.LCR will fit between studs when used horizontally but only if it is perfectly centered between the studs. Plan the placement of your on-wall TV and speakers very carefully before cutting holes. The DI 6.LCR will not fit between standard-spaced wall studs when used in a horizontal orientation. If you wish to use a DI 6.LCR as a horizontal center channel speaker or if you cannot center a DI 5.LCR between studs, consult a professional installer.

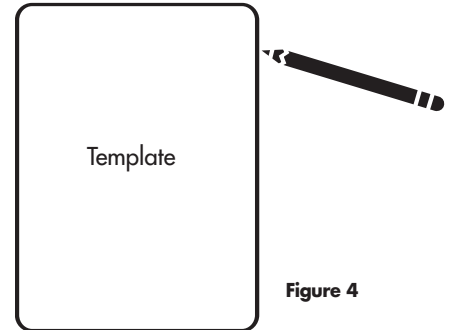

Figure 4

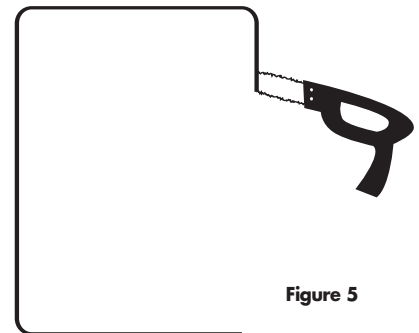
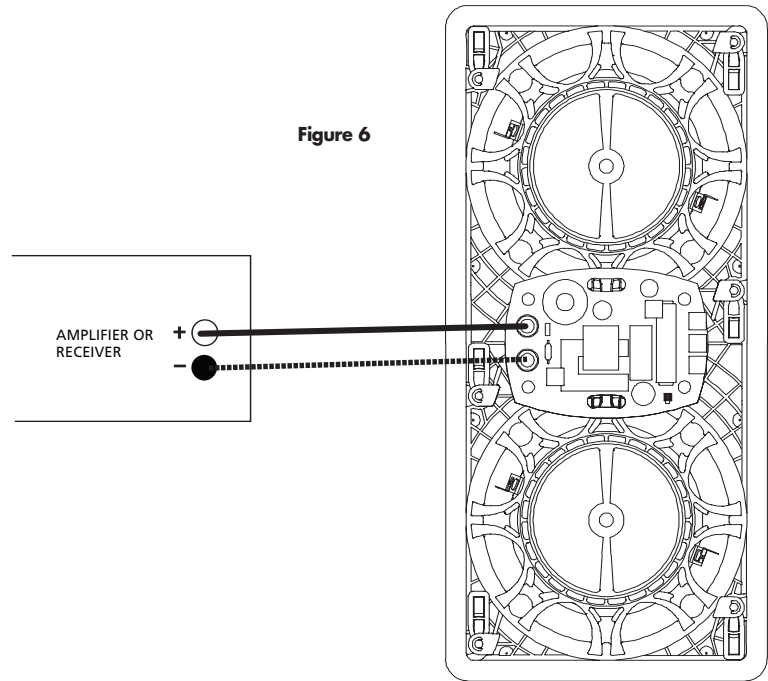

Figure 5

- Using the supplied template, trace the installation location with a pencil. You can do this by holding the template in your preferred location and tracing around it. Use a bubble level to square and level the template [Figure 4].
- Carefully cut the hole with the appropriate cutting tool for your wall or ceiling material. Start the hole by drilling a hole on the inside of the tracing (with the drill bit just inside the line). Use this hole to insert the saw or knife and begin cutting [Figure 5].
- Once you have cut the hole, pull the speaker wire out of the hole and connect the speaker. Strip 1/2" (12 mm) of insulation from each of the two conductors of the wire to expose the bare metal and twist each of the conductors into a single unfrayed strand. Note that one of the terminals on the rear of each speaker is marked red (+) and the other black (-). Make certain that you connect the wire from the red terminal (+) of your amplifier or receiver to the red terminal (+) on your speaker and the wire from the black terminal (-) of your amplifier or receiver to the black terminal (-) on your speaker. Most wire has some indicator (such as color-coding, ribbing or writing) on one of the two conductors to help you maintain consistency [Figure 6].

## Installation Continued

- Push down on the top of the terminal to reveal the wire hole in the side of the terminal post and insert the wire into the hole [Figure 7]. Release the pressure on the terminal to secure the wire.
- Loosen the rotating lock arms by turning the lock arm screws on the front of the speaker counter clockwise 1/2 to 1 turn, just enough to allow the lock arm to move freely. [Figure 8]. Make sure that the rotating lock arms are flipped inwards [Figure 9] so that the speaker fits into the cutout.
- Place the speaker carefully into the cutout. If you have a bubble level, use it to help you correctly align the speaker. Tighten the lock arm screws with a screwdriver [Figure 10]. This will rotate the lock arms [Figure 11] and secure the speaker to the wall/ceiling. Do not over-tighten the lock arm screws. If you are using a powered screwdriver or drill set the torque to a value of 7 in. – lb. (8dN – m).
- Install the grille on the speaker frame. Powerful magnets hold the grille in place.



## SAFETY FIRST

When installing your DI Series Loudspeakers, be aware of the weight of your particular model (see specification page for the weight of your model) and the sturdiness of the material into which you are installing the speaker. Also be aware of any concealed studs, electrical wiring or plumbing in the wall or ceiling into which you are installing the speakers. If you are not sure of a safe way to install these speakers, consult a professional installer, your authorized Definitive Technology dealer, or a building contractor.

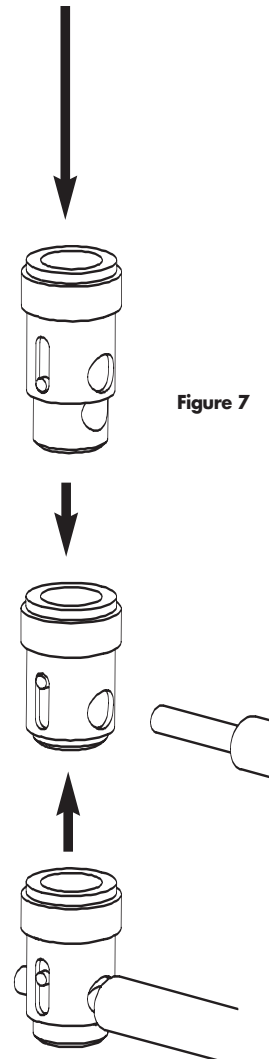

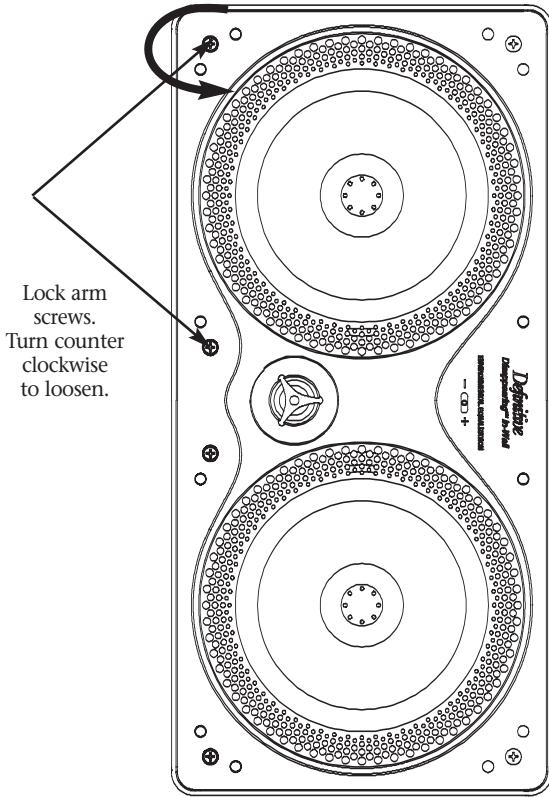

Figure 8

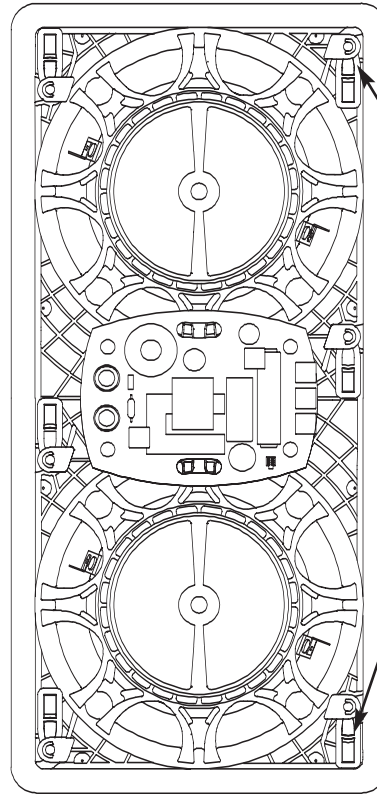

Figure 9

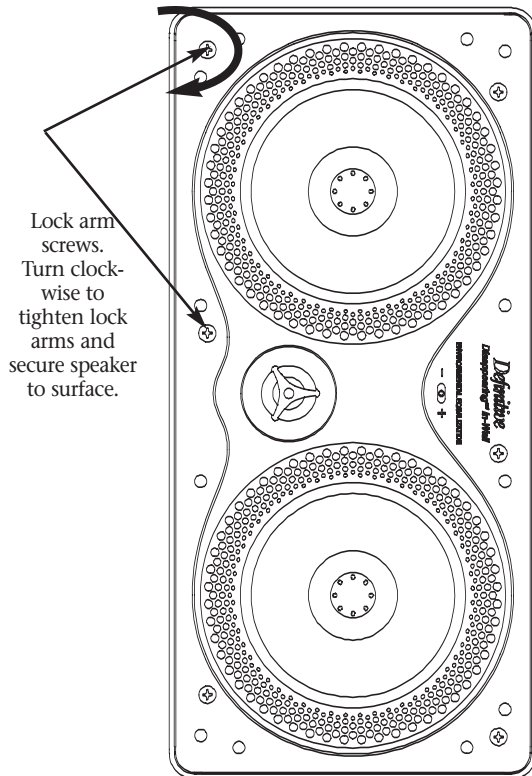

Figure 10

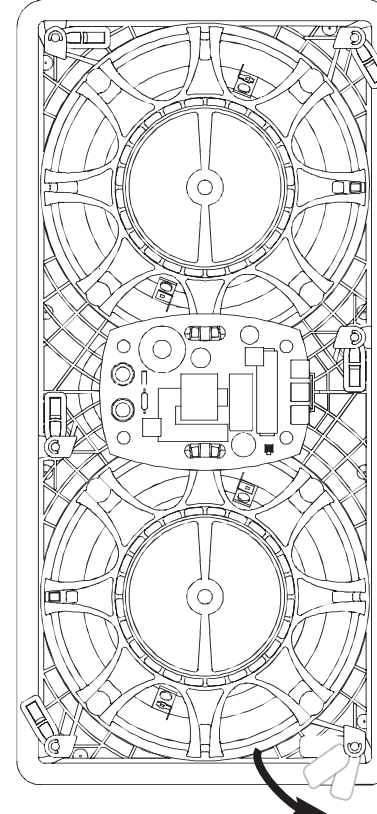
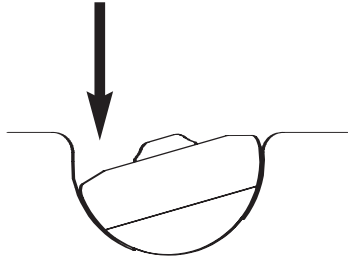
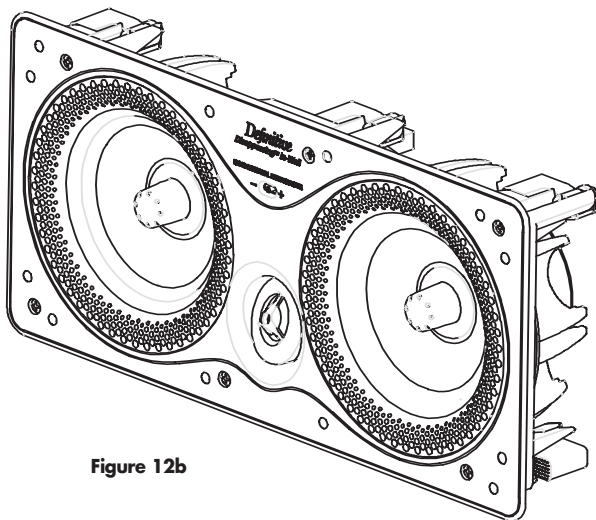

Figure 11



**Figure 12a**

Push gently to set angle.



**Figure 12b**

## Aiming the Tweeter

To aim the tweeter, first install the speaker in the desired location. Gently push the tweeter in the direction you wish to point it [figure 12a & 12b]. For rear/surround speakers, aim the tweeter toward the nearest reflecting surface (an adjacent wall or ceiling) for a more diffuse sound field (if you want a more direct sound, aim the tweeters at your listening position).

## Environmental EQ

If your listening room has smooth sheetrock walls, hardwood floors, and non-cushioned furniture, the sound will be overly "bright" and unnatural. Engaging the Environmental EQ feature [figure 13] (by selecting the "-" setting) compensates for the effect of overly loud treble. If your room has a lot of absorbing surfaces such as over-stuffed furniture, heavy drapes and rugs such that the speakers sound "dull," engage the "+" setting to boost treble response. Leave the switch in the center position in rooms with a balance of reflecting and absorbing surfaces (most rooms fall into this category).

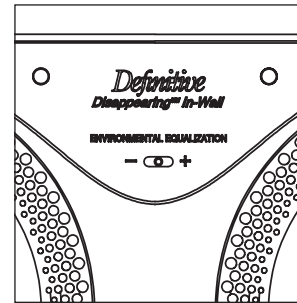

**Figure 13**



## NOTES

### Technical Assistance

---

It is our pleasure to offer assistance if you have any questions regarding your Definitive loudspeakers. Please contact your nearest Definitive Technology dealer or call us directly at (800) 228-7148 (US & Canada) or 01 (410) 363-7148 (all other countries), or e-mail us at [info@definitivetech.com](mailto:info@definitivetech.com).

### Service

---

Service work on your Definitive loudspeakers will normally be performed by your local Definitive Technology dealer. If your dealer is unable or unwilling to perform service, contact us for alternative options. Please note that the address given in this manual is the address of our offices only. **Under no circumstances should loudspeakers be shipped to our offices or returned without contacting us first and obtaining return authorization.**

Definitive Technology Offices  
 11433 Cronridge Drive  
 Owings Mills, Maryland 21117  
 Phone: (800) 228-7148 (US & Canada)  
 01 (410) 363-7148 (all other countries)

### WARNING: LISTEN CAREFULLY

---

Definitive Technology loudspeakers and subwoofers are capable of playing at extremely high volume levels, which could cause serious or permanent hearing damage. Definitive Technology accepts no liability for hearing loss, bodily injury or property damage resulting from the misuse of its products.

You should limit prolonged exposure to volumes that exceed 85 decibels (dB).

For more about safe volume levels, refer to the Occupational Health and Safety Administration (OSHA) guidelines at: [www.osha.gov/dts/osta/otm/noise/standards\\_more.html](http://www.osha.gov/dts/osta/otm/noise/standards_more.html).

### 5.5BPS

---

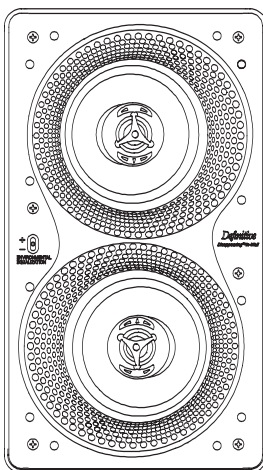

*The DI 5.5BPS is the perfect surround speaker to use with DI LCR models in home theater systems.*

## LIMITED USA WARRANTY 5-YEARS FOR DRIVERS AND CABINETS, 3-YEARS FOR ELECTRONIC COMPONENTS

DEI Sales Co., dba Definitive Technology (herein "Definitive") warrants to the original retail purchaser only that this Definitive loudspeaker product (the "Product") will be free from defects in material and workmanship for a period of five (5) years covering the drivers and cabinets, and three (3) years for the electronic components from the date of the original purchase from a Definitive Authorized Dealer. If the Product is defective in material or workmanship, Definitive or its Authorized Dealer will, at its option, repair or replace the warranted product at no additional charge, except as set forth below. All replaced parts and Product(s) become the property of Definitive. Product that is repaired or replaced under this warranty will be returned to you, within a reasonable time, freight collect. This warranty is non-transferrable and is automatically void if the original purchaser sells or otherwise transfers the Product to any other party.

*This Warranty does not include service or parts to repair damage caused by accident, misuse, abuse, negligence, inadequate packing or shipping procedures, commercial use, voltage in excess of the rated maximum of the unit, cosmetic appearance of cabinetry not directly attributable to defects in material or workmanship. This warranty does not cover the elimination of externally generated static or noise, or the correction of antenna problems or weak reception. This warranty does not cover labor costs or damage to the Product caused by installation or removal of the Product. Definitive Technology makes no warranty with respect to its products purchased from dealers or outlets other than Definitive Technology Authorized Dealer.*

**THE WARRANTY IS AUTOMATICALLY VOID IF:**

- 1) The product has been damaged, altered in any way, mishandled during transportation, or tampered with.
- 2) The product is damaged due to accident, fire, flood, unreasonable use, misuse, abuse, customer applied cleaners, failure to observe manufacturers warnings, neglect or related events.
- 3) Repair or modification of the Product has not been made or authorized by Definitive Technology.
- 4) The product has been improperly installed or used.

Product must be returned (insured and prepaid), together with the original dated proof of purchase to the Authorized Dealer from whom the Product was purchased, or to the nearest Definitive factory service center. Product must be shipped in the original shipping container or its equivalent. Definitive is not responsible or liable for loss or damage to Product in transit.

THIS LIMITED WARRANTY IS THE ONLY EXPRESS WARRANTY THAT APPLIES TO YOUR PRODUCT. DEFINITIVE NEITHER ASSUMES NOR AUTHORIZES ANY PERSON OR ENTITY TO ASSUME FOR IT ANY OTHER OBLIGATION OR LIABILITY IN CONNECTION WITH YOUR PRODUCT OR THIS WARRANTY. ALL OTHER WARRANTIES, INCLUDING BUT NOT LIMITED TO EXPRESS, IMPLIED, WARRANTY OF MERCHANTABILITY OR FITNESS FOR A PARTICULAR PURPOSE, ARE EXPRESSLY EXCLUDED AND DISCLAIMED TO THE MAXIMUM EXTENT ALLOWED BY LAW. ALL IMPLIED WARRANTIES ON PRODUCT ARE LIMITED TO THE DURATION OF THIS EXPRESSED WARRANTY. DEFINITIVE HAS NO LIABILITY FOR ACTS OF THIRD PARTIES. DEFINITIVE'S LIABILITY, WHETHER BASED ON CONTRACT, TORT, STRICT LIABILITY, OR ANY OTHER THEORY, SHALL NOT EXCEED THE PURCHASE PRICE OF THE PRODUCT FOR WHICH A CLAIM HAS BEEN MADE. UNDER NO CIRCUMSTANCE WILL DEFINITIVE BEAR ANY LIABILITY FOR INCIDENTAL, CONSEQUENTIAL OR SPECIAL DAMAGES. THE CONSUMER AGREES AND CONSENTS THAT ALL DISPUTES BETWEEN THE CONSUMER AND DEFINITIVE SHALL BE RESOLVED IN ACCORDANCE WITH CALIFORNIA LAWS IN SAN DIEGO COUNTY, CALIFORNIA. DEFINITIVE RESERVES THE RIGHT TO MODIFY THIS WARRANTY STATEMENT AT ANY TIME.

Some states do not allow the exclusion or limitation of consequential or incidental damages, or implied warranties, so the above limitations may not apply to you. This warranty gives you specific legal rights, and you may also have other rights which vary from state to state.



This product complies with the essential requirements of the EMC directive 89/336/EEC.

©2009 DEI Sales Co. All rights reserved.

### Other Disappearing In-Wall Series Speakers

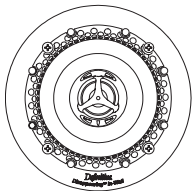

DI 3.5R

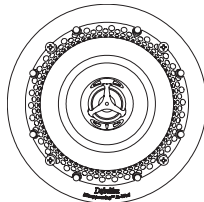

DI 4.5R

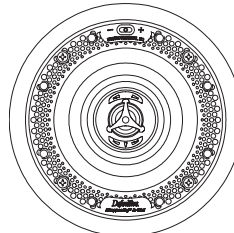

DI 5.5R

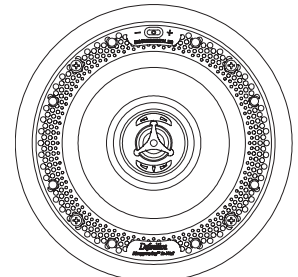

DI 6.5R

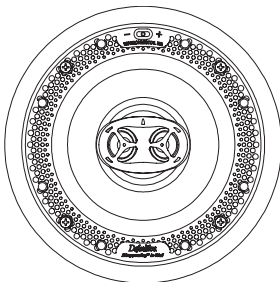

DI 6.5STR



DI 8R

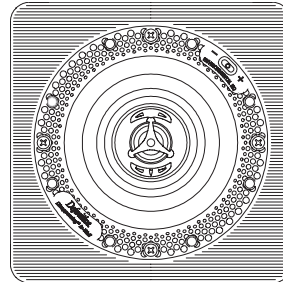

DI 5.5S

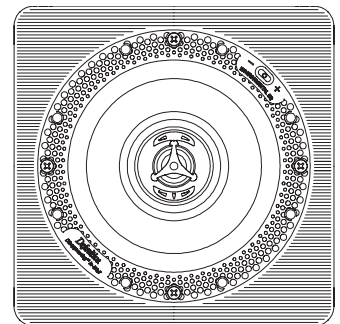

DI 6.5S