

# DENON®

## AVR-X1500H

INTEGRATED NETWORK AV RECEIVER

# Quick Start Guide

Kurzanleitung / Guide de démarrage rapide / Guida di Avvio Rapido /  
Guía de inicio rápido / Snelhandleiding / Snabbstartsguide /  
Краткое руководство пользователя / Skrócona instrukcja obsługi

## Read Me First....

Bitte zuerst lesen... / Lisez-moi en premier.... / Nota preliminare.... /  
Lea esto primero.... / Lees mij eerst... / Läs detta först... /  
Прочитайте в первую очередь... / Przeczytaj to najpierw....



**AVAILABLE AT  
DIGITAL CINEMA**

ENGLISH

DEUTSCH

FRANÇAIS

ITALIANO

ESPAÑOL

NEDERLANDS

SVENSKA

РУССКИЙ

POLSKI

# Welcome

Thank you for choosing a Denon AV receiver.

This guide provides step-by-step instructions for setting up your AV receiver.

**Please do not return this unit to the store – call for assistance.**

**If you need help... :**

If you need additional help in solving problems, contact Denon customer service in your area.

[www.denon.com](http://www.denon.com)

# Before You Begin

## Required for Setup

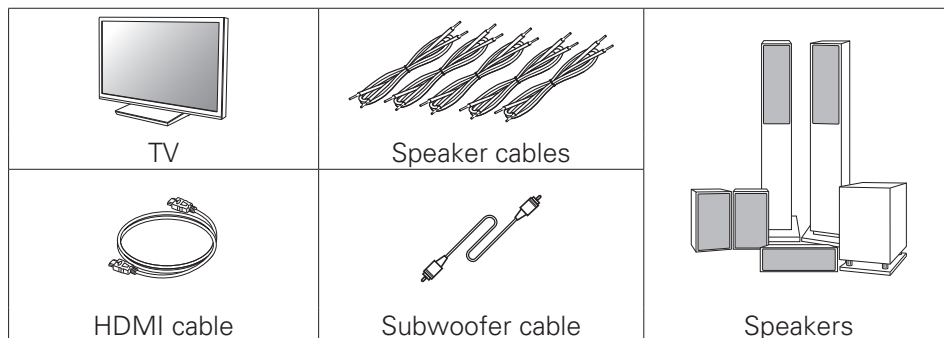



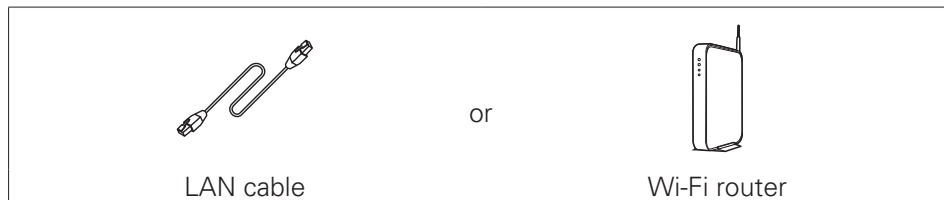







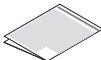

## Optional

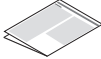

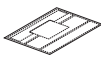
- When connecting this unit to a device that is compatible with the Deep Color, 4K and ARC functions, use a “High Speed HDMI cable with Ethernet” that displays the HDMI logo.
- These drawings are for illustrative purposes only and may not represent the actual product(s).

# What's In the Box

Quick Start Guide		FM indoor antenna	
Safety Instructions		AM loop antenna	
Cautions on Using Batteries		Sound calibration microphone	
Notes on radio		Sound calibration microphone stand	
Cable labels		Remote control unit (RC-1227)	
Receiver		R03/AAA batteries	
Power cord			



- The included sound calibration microphone stand is convenient for use when performing Speaker Calibration. Using your own tripod or the supplied Sound calibration microphone stand enables settings to be automatically configured to the optimum listening environment, providing exceptionally high performance.

# Setup

There are four steps to the setup process.

**1** Installing batteries in the remote control unit

**2** Connecting the receiver

**3** Following the On-Screen Setup Assistant

**4** Downloading the Mobile Apps

## **1** Installing batteries in the remote control unit

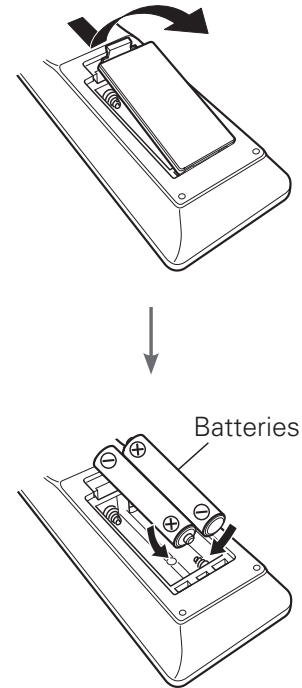

## 2 Connecting the receiver

- 1) Place the receiver near your TV and connect the power cord

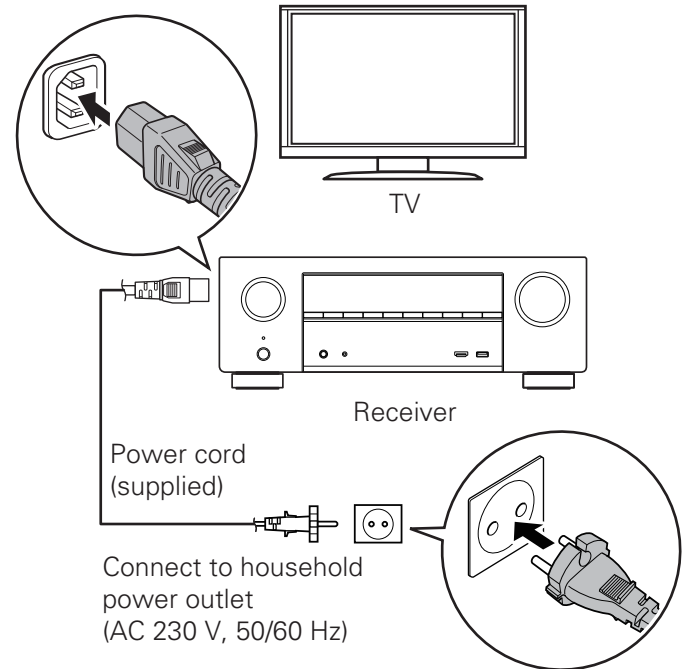

## 2) Connect the receiver to your home network

### Wired LAN

Connect an Ethernet cable (not included) between your receiver and your network router.

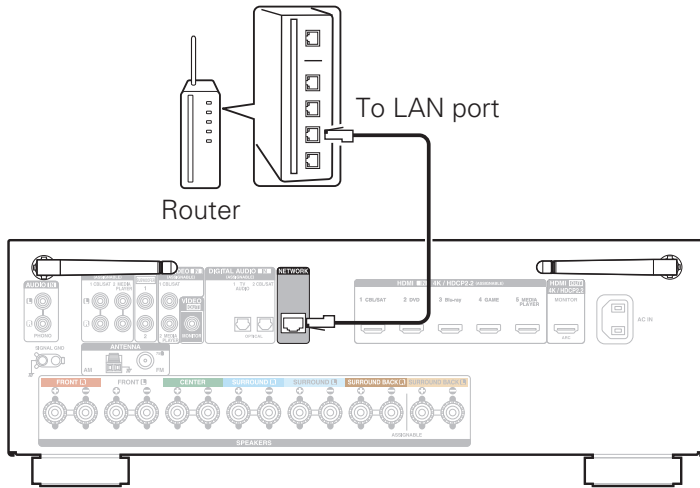

### Wireless LAN

Rotate the two antennas located on the back of the receiver upwards for maximum performance.

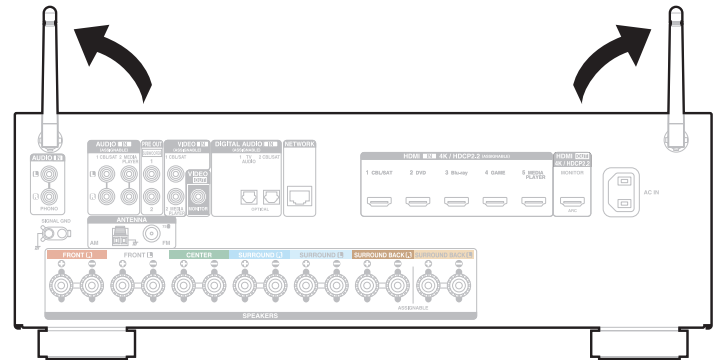

### 3) Connect the receiver to your TV with an HDMI cable

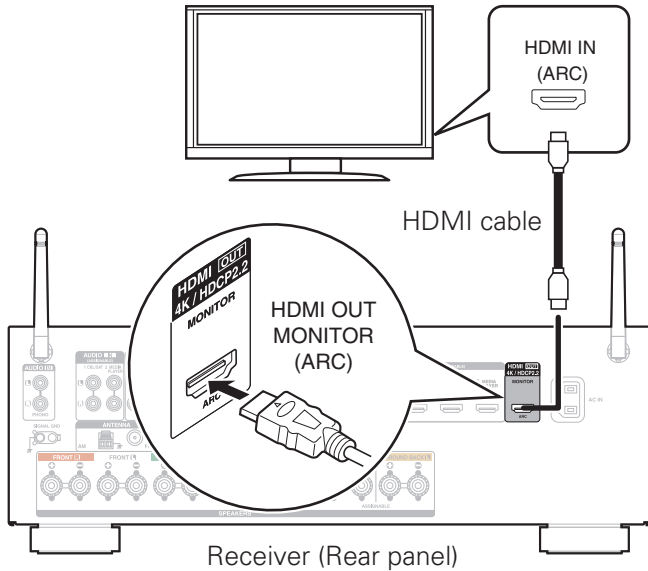

#### ARC (Audio Return Channel) :

If your TV supports ARC, your TV can send audio back to the AV receiver when you are using your TV's built-in video sources (TV tuner, Smart TV streaming services, etc...) ARC requires that you enable HDMI CEC on your TV. Please refer to your TV's Owner's Manual for instructions on how to setup HDMI CEC. Note that some TV manufacturers use other names for the HDMI CEC function.

### 4) Turn on the TV

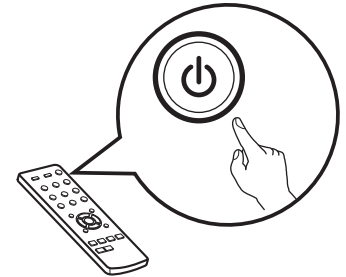
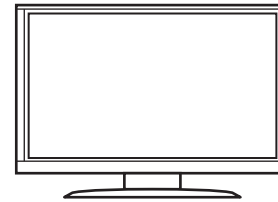

TV remote control unit

### 5) Select the appropriate HDMI input on your TV

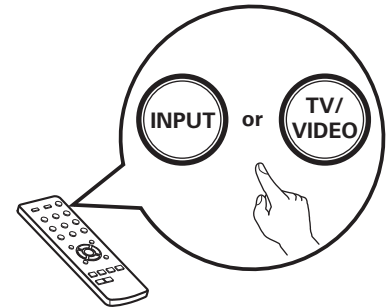
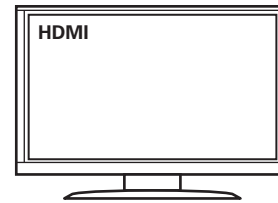

TV remote control unit

## 6) Turn on the receiver

- Press  to turn on the receiver.

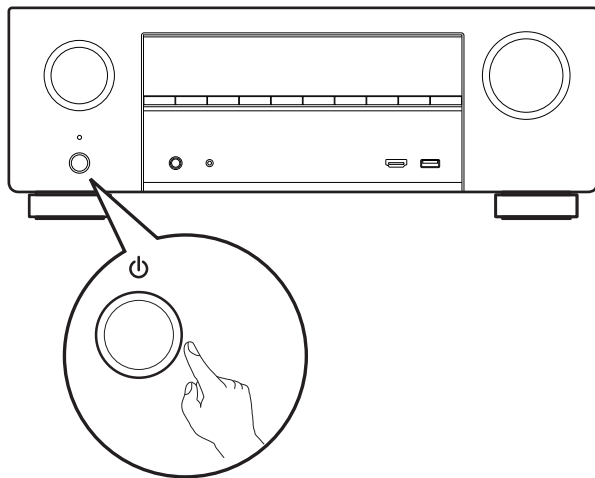

## 7) Verify the connection

- Verify that you can see this screen on your TV.



If this screen is not displayed, please go back and retry the steps again in the recommended sequence.



### 3 Following the On-Screen Setup Assistant

The Setup Assistant will walk you through connecting and configuring your speakers and components to your Denon receiver. Please use the remote control and follow the on-screen instructions.

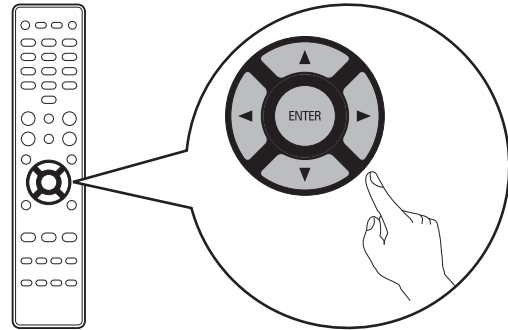

## 4 Downloading the Mobile Apps

Download both the “HEOS” App and the “Denon 2016 AVR Remote” App for the full home entertainment experience. The HEOS App is required to access online music through your AVR.

### HEOS



The HEOS App allows you to explore, browse, and play music from many online streaming services or from your own music library.



### Denon 2016 AVR Remote



Control your new AVR with the latest Denon 2016 AVR Remote App. Volume control, sound mode selection and advanced settings are always only a tap away.



# Owner's Manual

- For more information, visit [www.denon.com](http://www.denon.com)
- Refer to the Online Manual for other functions information and operation procedure details.  
[manuals.denon.com/AVRX1500H/EU/EN/](http://manuals.denon.com/AVRX1500H/EU/EN/)



Online Manual



**DENON®**  
[www.denon.com](http://www.denon.com)

Printed in Vietnam 5411 11588 00AD  
Copyright © 2018 D&M Holdings Inc. All Rights Reserved.