



DENON



**AVAILABLE AT
DIGITAL CINEMA**

PMA-720AE / PMA-520AE
INTEGRATED AMPLIFIER

Owner's Manual

Preparations

Operations

Information





SAFETY PRECAUTIONS



CAUTION
RISK OF ELECTRIC SHOCK
DO NOT OPEN



CAUTION:

TO REDUCE THE RISK OF ELECTRIC SHOCK, DO NOT REMOVE COVER (OR BACK). NO USER-SERVICEABLE PARTS INSIDE. REFER SERVICING TO QUALIFIED SERVICE PERSONNEL.



The lightning flash with arrowhead symbol, within an equilateral triangle, is intended to alert the user to the presence of uninsulated "dangerous voltage" within the product's enclosure that may be of sufficient magnitude to constitute a risk of electric shock to persons.



The exclamation point within an equilateral triangle is intended to alert the user to the presence of important operating and maintenance (servicing) instructions in the literature accompanying the appliance.

WARNING:

TO REDUCE THE RISK OF FIRE OR ELECTRIC SHOCK, DO NOT EXPOSE THIS APPLIANCE TO RAIN OR MOISTURE.



CAUTION:

HOT SURFACE. DO NOT TOUCH.

The top surface over the internal heat sink may become hot when operating this product continuously. Do not touch hot areas, especially around the "Hot surface mark" and the top panel.

IMPORTANT SAFETY INSTRUCTIONS

1. Read these instructions.
2. Keep these instructions.
3. Heed all warnings.
4. Follow all instructions.
5. Do not use this apparatus near water.
6. Clean only with dry cloth.
7. Do not block any ventilation openings. Install in accordance with the manufacturer's instructions.
8. Do not install near any heat sources such as radiators, heat registers, stoves, or other apparatus (including amplifiers) that produce heat.
9. Protect the power cord from being walked on or pinched particularly at plugs, convenience receptacles, and the point where they exit from the apparatus.
10. Only use attachments/accessories specified by the manufacturer.
11. Use only with the cart, stand, tripod, bracket, or table specified by the manufacturer, or sold with the apparatus. When a cart is used, use caution when moving the cart/apparatus combination to avoid injury from tip-over.
12. Unplug this apparatus during lightning storms or when unused for long periods of time.
13. Refer all servicing to qualified service personnel. Servicing is required when the apparatus has been damaged in any way, such as power-supply cord or plug is damaged, liquid has been spilled or objects have fallen into the apparatus, the apparatus has been exposed to rain or moisture, does not operate normally, or has been dropped.
14. Batteries shall not be exposed to excessive heat such as sunshine, fire or the like.



CAUTION:

To completely disconnect this product from the mains, disconnect the plug from the wall socket outlet. The mains plug is used to completely interrupt the power supply to the unit and must be within easy access by the user.

DECLARATION OF CONFORMITY

We declare under our sole responsibility that this product, to which this declaration relates, is in conformity with the following standards: EN60065, EN55013, EN55020, EN61000-3-2 and EN61000-3-3. Following the provisions of Low Voltage Directive 2006/95/EC and EMC Directive 2004/108/EC, the EC regulation 1275/2008 and its frame work Directive 2009/125/EC for Energy-related Products (ErP).

DENON EUROPE
Division of D&M Germany GmbH
An der Kleinbahn 18, Nettetal,
D-41334 Germany

A NOTE ABOUT RECYCLING:

This product's packaging materials are recyclable and can be reused. Please dispose of any materials in accordance with the local recycling regulations.

When discarding the unit, comply with local rules or regulations.

Batteries should never be thrown away or incinerated but disposed of in accordance with the local regulations concerning battery disposal.

This product and the supplied accessories, excluding the batteries, constitute the applicable product according to the WEEE directive.



Pb





NOTES ON USE

WARNINGS

- Avoid high temperatures.
Allow for sufficient heat dispersion when installed in a rack.
- Handle the power cord carefully.
Hold the plug when unplugging the cord.
- Keep the unit free from moisture, water, and dust.
- Unplug the power cord when not using the unit for long periods of time.
- Do not obstruct the ventilation holes.
- Do not let foreign objects into the unit.
- Do not let insecticides, benzene, and thinner come in contact with the unit.
- Never disassemble or modify the unit in any way.
- Ventilation should not be impeded by covering the ventilation openings with items, such as newspapers, tablecloths or curtains.
- Naked flame sources such as lighted candles should not be placed on the unit.
- Observe and follow local regulations regarding battery disposal.
- Do not expose the unit to dripping or splashing fluids.
- Do not place objects filled with liquids, such as vases, on the unit.
- Do not handle the mains cord with wet hands.
- When the switch is in the OFF (STANDBY) position, the equipment is not completely switched off from MAINS.
- The equipment shall be installed near the power supply so that the power supply is easily accessible.
- Do not keep the battery in a place exposed to direct sunlight or in places with extremely high temperatures, such as near a heater.

CAUTIONS ON INSTALLATION

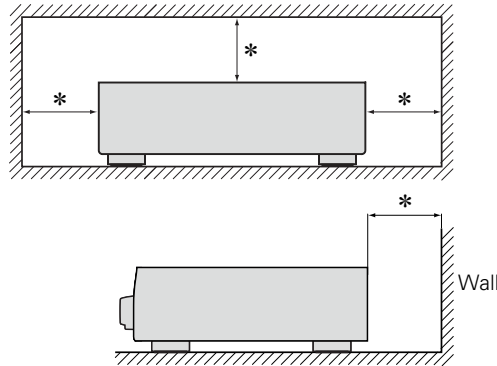

*** For proper heat dispersal, do not install this unit in a confined space, such as a bookcase or similar enclosure.**

- More than 0.3 m is recommended.
- Do not place any other equipment on this unit.





Getting started

Thank you for purchasing this DENON product. To ensure proper operation, please read this owner's manual carefully before using the product. After reading them, be sure to keep them for future reference.



Contents

Getting started	1
Accessories	2
Features	2
Cautions on handling	2

Preparations

[3](#)

Connections	4
Cables used for connections	4
Connecting the speakers	4
Connecting pre out jacks (PMA-720AE only)	7
Connecting players	7
Connecting a recorder	8
Connecting the power cord	8

Operations

[9](#)

Operations	10
Before use	10
Starting playback	10
Adjusting the tone (LOUDNESS)	11
Setting speakers to use (PMA-720AE only)	11
Using headphones	11
Starting recording	11
Setting the Auto Standby mode	11

Information

[12](#)

Part names and functions	13
Front panel	13
Rear panel	14
Remote control unit	15
Explanation terms	17
Troubleshooting	18
Specifications	19

Preparations

Operations

Information





Accessories

Check that the following parts are supplied with the product.

- ① Getting Started 1
- ② CD-ROM (Owner's manual) 1
- ③ Safety Instructions 1
- ④ Service network list..... 1
- ⑤ Remote control unit (RC-1173)..... 1
- ⑥ R03/AAA batteries..... 2

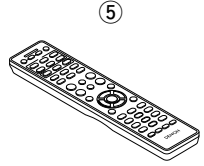

Features

Advanced HC (High-Current) single push-pull circuit installed to simultaneously achieve both "subtlety" and "powerfulness"

Employs HC transistors that pass 2 – 3 times the peak current of conventional audio power transistors, to acquire a stable, expressive quality of music from extremely low-levels to high volume.

High-speed, large current capacity power circuit

To draw out the full potential of the HC single push-pull circuit, the power circuit uses DENON custom-specification block type electrolytic capacitors, as well as SBD (Schottky-Barrier Diode) with short reverse recovery time and minimal current noise.

Source Direct function, for pure audio playback

Achieves pure audio playback, protecting the purity of the sound by by-passing TONE (BASS, TREBLE), LOUDNESS and BALANCE controls.

Reduced power consumption during standby

In consideration of the environment, power consumption during standby has been reduced to 0.3 W or better.

Cautions on handling

• Before turning the power on
Check once again that all connections are correct and that there are no problems with the connection cables.

• Power is supplied to some of the circuitry even when the unit is set to the standby mode. When going on vacation or leaving home for long periods of time, be sure to unplug the power cord from the power outlet.

• About condensation
If there is a major difference in temperature between the inside of the unit and the surroundings, condensation (dew) may form on the operating parts inside the unit, causing the unit not to operate properly.
If this happens, let the unit sit for an hour or two with the power turned off and wait until there is little difference in temperature before using the unit.

• Cautions on using mobile phones
Using a mobile phone near this unit may result in noise. If that occurs, move the mobile phone away from this unit when it is in use.

• Moving the unit
Turn off the power and unplug the power cord from the power outlet. Next, disconnect the connection cables to other system units before moving the unit.

• About care

- Wipe the cabinet and control panel clean with a soft cloth.
- Follow the instructions when using a chemical cleaner.
- Benzene, paint thinner or other organic solvents as well as insecticide may cause material changes and discoloration if brought into contact with the unit, and should therefore not be used.

Preparations

Operations







Information





Preparations

Here, we explain the connections and set up methods for this unit.

- Cables used for connections  [page 4](#)
- Connecting the speakers  [page 4](#)
- Connecting pre out jacks  [page 7](#)
- Connecting players  [page 7](#)
- Connecting a recorder  [page 8](#)
- Connecting the power cord  [page 8](#)





Connections



Connections for all compatible audio signal format is described in this operating instructions. Please select the types of connections corresponding to the equipment you are connecting.

NOTE

- Do not plug in the power cord until all connections have been completed.
- When making connections, also refer to the operating instructions of the other components.
- Be sure to connect the left and right channels properly (left with left, right with right).
- Do not bundle power cords with connection cables. Doing so can result in humming or noise.
- Do not turn up the volume without a turntable connected to the PHONO input terminals. Doing so will cause humming or noise.

❑ Cautions on playing SA sources:

When regular speakers not compatible with SA sources (DVD Audio discs, Super Audio CDs and other sources, including treble components above the audible range), set the properties of the player (DVD Audio player, Super Audio CD player, etc.) for use with regular speakers (or amplifiers).

The speakers may be damaged if the volume is set too high when playing SA sources. For instructions on player settings, refer to the operating instructions included with the player.

Cables used for connections

Select the cables according to the equipment being connected.

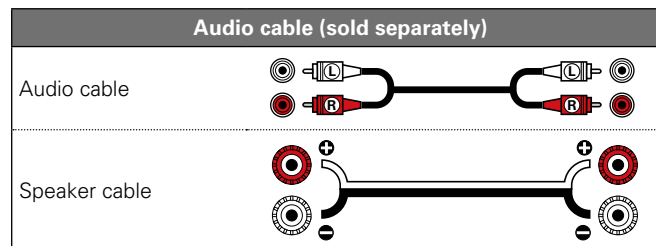

Connecting the speakers

Connecting the speakers cables

Carefully check the left (L) and right (R) channels and + (red) and - (black) polarities on the speakers being connected to the unit, and be sure to connect the channels and polarities correctly.

- 1 Peel off about 10 mm of sheathing from the tip of the speaker cable, then either twist the core wire tightly or apply solder to it.**
- 2 Turn the speaker terminal counterclockwise to loosen it.**
- 3 Insert the speaker cable's core wire to all the way into the speaker terminal.**
- 4 Turn the speaker terminal clockwise to tighten it.**

NOTE

- Connect the speaker cables so they do not stick out of the speaker terminals. The protection circuit may be activated if the wires touch the rear panel or if the + and - sides touch each other ([page 5](#) "Protection circuit").
- Never touch the speaker terminals while the power supply is connected. Doing so could result in electric shock.

See overleaf



Speaker impedance

Use speakers with impedances within the ranges shown below to suit how they are used.

Speakers used	Impedance
A	4 – 16 Ω
B (PMA-720AE only)	4 – 16 Ω
A and B (PMA-720AE only)	8 – 16 Ω
Bi-wiring connection (PMA-720AE only)	4 – 16 Ω

Protection circuit

The protection circuit is activated in the following situations:

- If the speaker cable wire touches the rear panel or screws or if the speaker cable wire touches the speaker cable's + and – sides are touching
- If the surrounding temperature is extremely high
- If the inside of the amplifier gets hot to extended use at a high output

If this happens, unplug the power cord, then check the connections of the speaker cables and input cables. If the unit becomes very hot, wait for it to cool off and improve the ventilation around it. After doing this, plug the power cord back in.

If the protection circuit is activated even though there are no problems with the ventilation around the unit or in connections, the unit may be damaged. Turn off the power and then contact a DENON service center.

Speaker A/B connection (PMA-720AE only)

- The same signal is output from the SPEAKER A and B terminals.
- When only one set of speakers is to be connected, use either the SPEAKER A or B terminals.

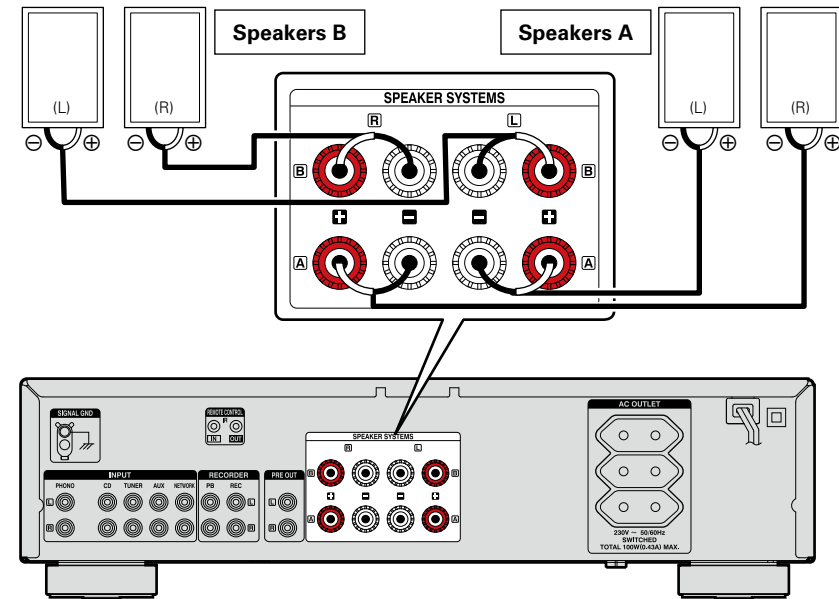

Speaker connection (PMA-520AE only)

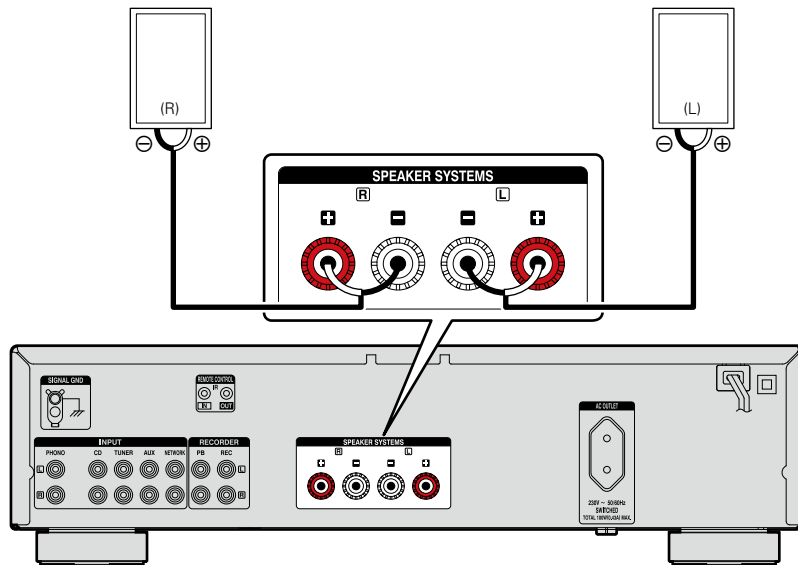

Bi-wiring connection (PMA-720AE only)

- When bi-wiring with bi-wireable speakers, connect the mid and high range terminals to SYSTEM (A) (or SYSTEM (B)), the low range terminals to SYSTEM (B) (or SYSTEM (A)).
- This enables playback with minimal interference between the high-range speaker unit and the low-range speaker unit.

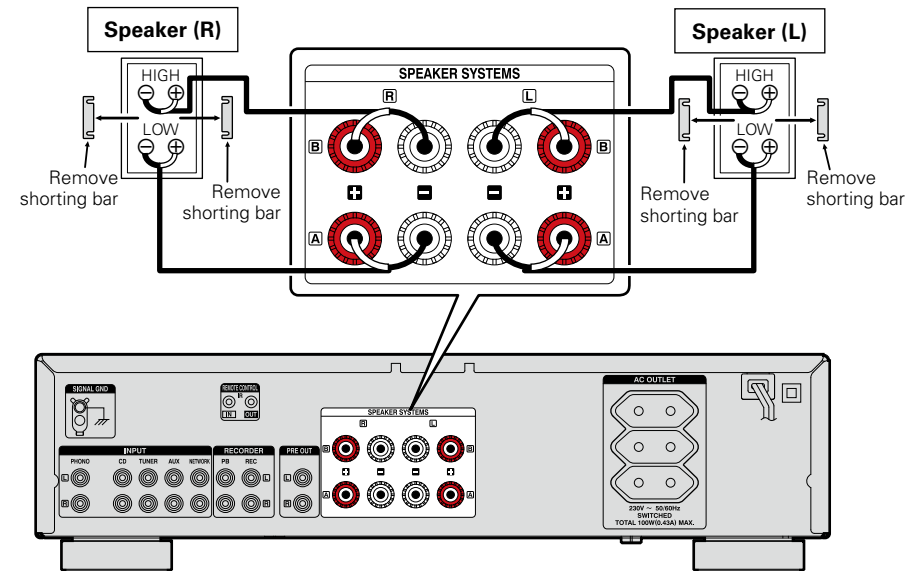



Connecting pre out jacks (PMA-720AE only)

If you use a power amplifier or subwoofer, connect it as shown below, and then you can use this unit as a preamplifier.

For connecting speaker systems, refer to the instruction manual supplied with the power amplifier to be used.

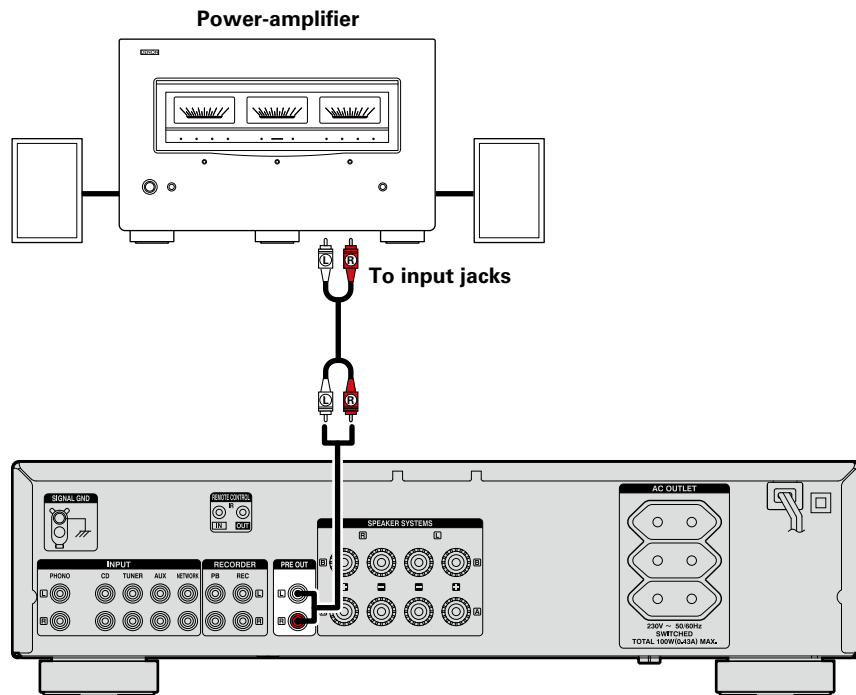

NOTE

- NEVER insert the short-circuiting pin plug into the PRE OUT terminals. Doing so could result in damage.
- Signals are output from the PRE OUT terminals even when using headphones.

Connecting players

If humming or other noise is generated when the ground wire is connected, disconnect it.

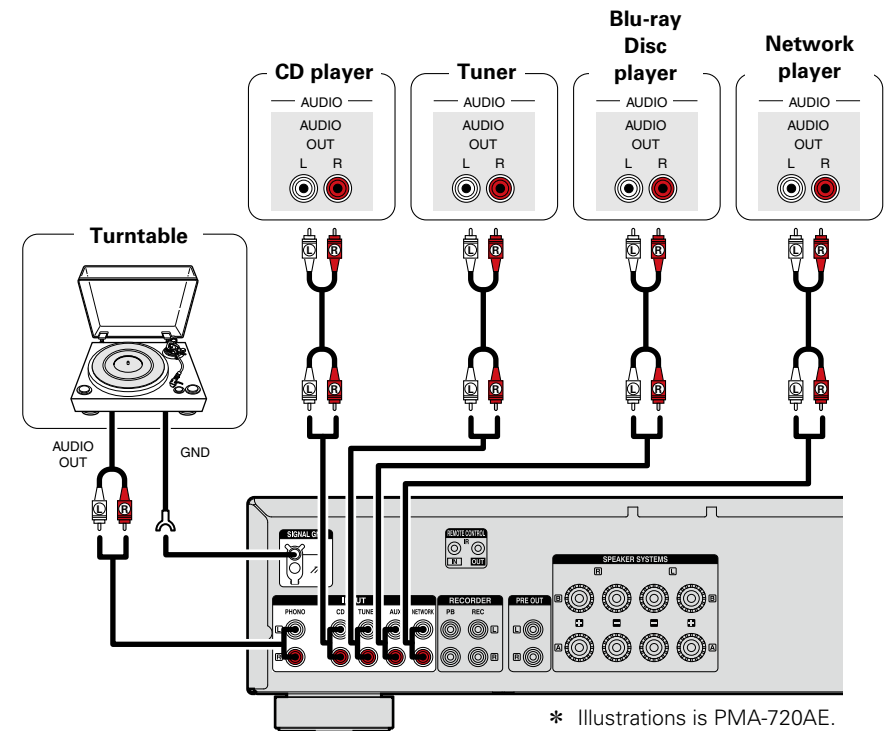

* Illustrations is PMA-720AE.



Connecting a recorder

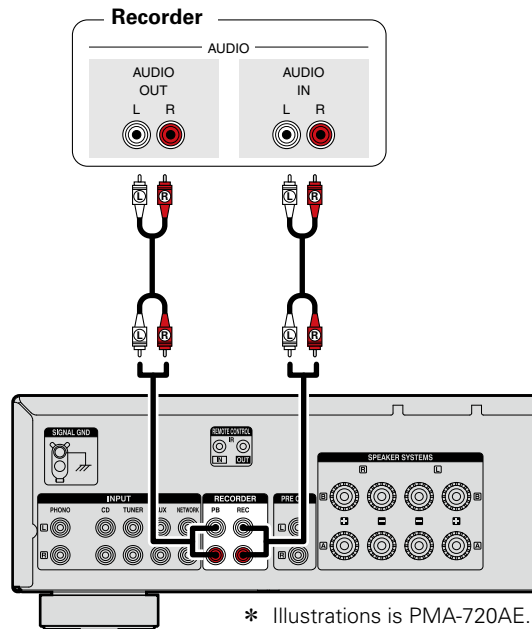

NOTE

NEVER insert the short-circuiting pin plug into the recording output. Doing so could result in damage.

Connecting the power cord

Wait until all connections have been completed before connecting the power cord.

□ PMA-720AE

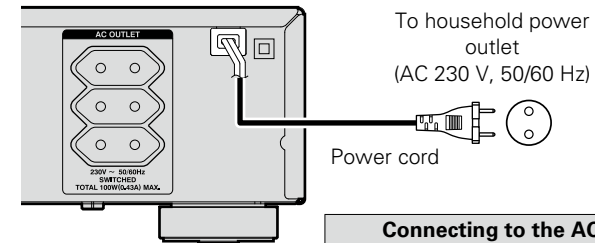

To household power outlet
(AC 230 V, 50/60 Hz)

Power cord

Connecting to the AC OUTLET

SWITCHED (Total capacity: 100 W (0.43 A):
The power supply to the outlet turns ON and OFF with the main unit's **POWER** switch.
Make sure the total power consumption of the connected devices does not exceed 100 W (0.43 A).

□ PMA-520AE

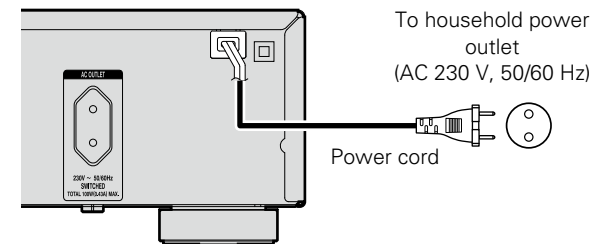

To household power outlet
(AC 230 V, 50/60 Hz)

Power cord

NOTE







- Only use the AC OUTLET for audio equipment. Never use it for hair driers, TVs or other electrical appliances.
- Insert the plugs securely. Loose connections will result in the generation of noise.





Operations

Here, we explain functions and operations that let you make better use of this unit.

- Before use  [page 10](#)
- Starting playback  [page 10](#)
- Adjusting the tone (LOUDNESS)  [page 11](#)
- Setting speakers to use (PMA-720AE only)  [page 11](#)
- Using headphone set  [page 11](#)
- Starting recording  [page 11](#)
- Setting the Auto Standby mode  [page 11](#)



Operations

Before use

- 1 Turn the **VOLUME** on the main unit all the way down.
- 2 Set **SOURCE DIRECT** on the main unit to “**OFF**”.
- 3 Set **BASS**, **TREBLE** and **BALANCE** on the main unit to the center positions.
- 4 Press **POWER** on the main unit.
The power indicator blinks red for several seconds, then lights green.

Turning the power off

- 1 Press **AMP POWER**.
The power is set to the standby mode.
- 2 Press **POWER** on the main unit.
The power indicator turns off, and so does the power.

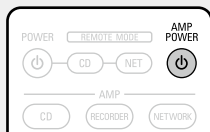

NOTE

Power continues to be supplied to some of the circuitry even when the power is in the standby mode. When leaving home for long periods of time or when going on vacation, either press **POWER** on the main unit to turn off the power, or unplug the power cord from the power outlet.

Starting playback

- 1 Press the input source select button (**CD**, **RECORDER**, **NETWORK**, **PHONO**, **AUX** or **TUNER**) to be played back.
 - The desired input source can be selected directly.
 - The input indicator on the main unit for the selected source lights.
- 2 Play the selected source.
- 3 Adjust **VOLUME** **▲▼** to the desired level.

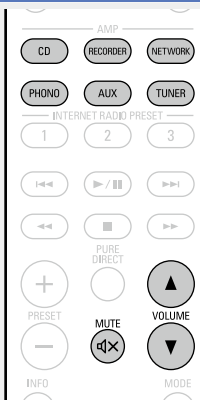

- 4 Adjust the tone with **BASS**, **TREBLE** and **BALANCE** on the main unit.
 - When **VOLUME** on the main unit is turned just past the “12 o’clock” position (over halfway), the effect of **BASS** and **TREBLE** on the main unit adjustments decreases.
 - When **VOLUME** on the main unit is turned to maximum or all the way clockwise, the bases and treble can no longer be adjusted.
- 5 If there is no need to adjust the tone, press **SOURCE DIRECT** on the main unit.

- When switched “**ON**”, the signal does not pass through the tone adjustment circuitry (bass, treble and balance), resulting in playback of a higher sound quality.
- When set to “**OFF**”, the sound can be adjusted to suit your taste.

- 6 Press **MUTE** to mute the sound.
The power indicator on the main unit blinks red.
 - Press again for sound.

You can also use the following operation to select an input source.

Using the knob on the main unit

Turn **INPUT SELECTOR**.

- Turning **INPUT SELECTOR** switches the input source, as shown below.





Adjusting the tone (LOUDNESS)

When the sound volume is low and you press LOUDNESS to the "■ON" state, bass and treble sounds, which are hard to hear at a low volume level, are enhanced so that you can enjoy a more natural sound.

Press LOUDNESS on the main unit.

- Press the button again to the "■OFF" state to return to the original balance.



Setting speakers to use (PMA-720AE only)

Press SPEAKERS A or B on the main unit.

- When A (or B) is set to "■ON", sound is produced from the speakers connected to the A (or B) speaker output terminals.
- When both A and B are set to "■ON", sound is produced from the speakers connected to both the A and B speaker output terminals.
- When both A and B are set to "■OFF", no sound is produced from the speakers. Use this when listening over headphones.

Using headphones

Plug headphones into PHONES jack.

The speaker output turns off when the headphones are plugged in (PMA-520AE only).

NOTE

To prevent hearing loss, do not raise the volume level excessively when using headphones.

Starting recording

- 1 Press the input source select button (CD, NETWORK, PHONO, AUX or TUNER) to be recorded.

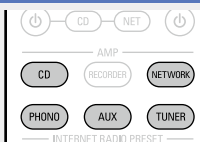

- 2 Set the recorder to the record mode.

- 3 Start playing the source to be recorded.

Setting the Auto Standby mode

When there is no operation or input signal for 30 minutes, this unit automatically enters the standby mode.

- The default setting is "On".

Press and hold AMP POWER for at least 5 seconds.

- Auto Standby mode is switched between Off and On.
- The Power indicator indicates Auto Standby mode Off/On during Standby, as shown below.

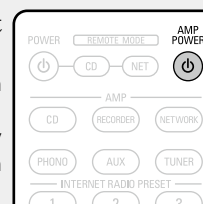

Auto Standby mode "Off" ← "Lit in red" ↔ "Unlit" → Auto Standby mode "On"

- The Power indicator flashes in red during Auto Standby mode setting.





If you set the Auto Standby mode while the unit is ON, the unit will enter the standby mode as soon as the Auto Standby mode setting is completed.





Information

Here, we list various information related to this unit.
Please refer to this information as needed.

- Part names and functions  [page 13](#)
- Troubleshooting  [page 18](#)
- Specifications  [page 19](#)





Part names and functions

For buttons not explained here, see the page indicated in parentheses ().



Front panel

□ PMA-720AE

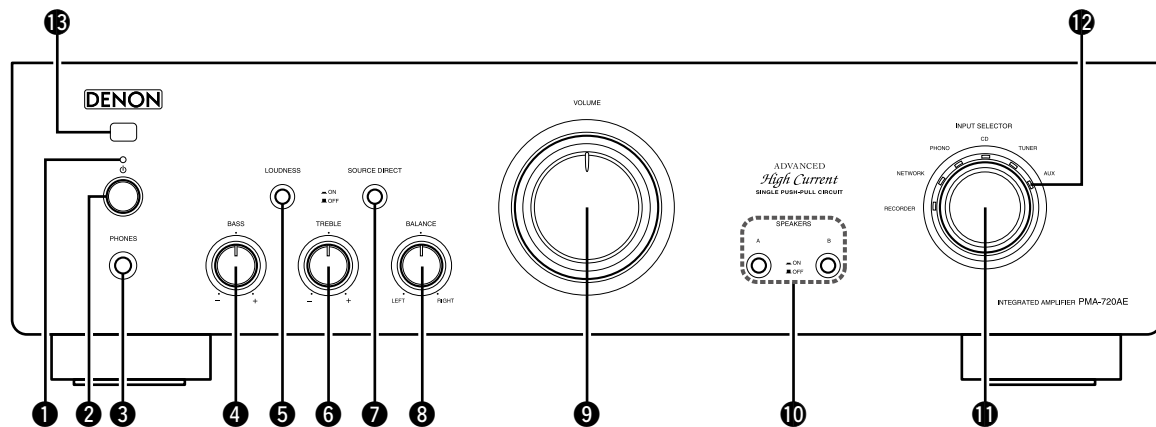

□ PMA-520AE

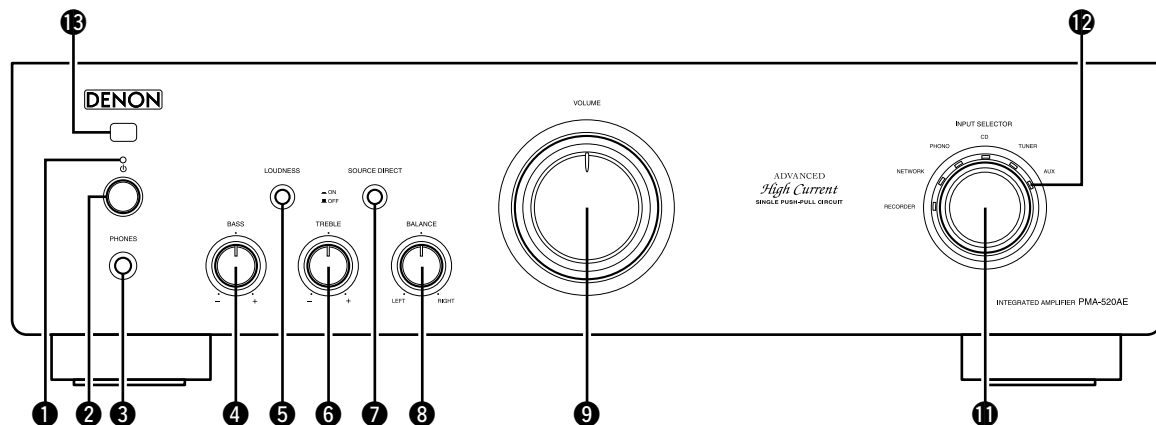

- 1 Power indicator** (10)
Indicates the status of the unit's as follows:
 - For several seconds after the power is turned on Red (blinking)
 - Power "ON" Green
 - Muting Red (blinking)
 - Standby Red
 - Power "OFF" Off
 - Auto Standby mode "ON" Off
- 2 Power operation switch (⏻)** (10)
- 3 Headphone jack (PHONES)** (11)
- 4 BASS control knob** (10)
- 5 LOUDNESS switch** (11)
- 6 TREBLE control knob** (10)
- 7 SOURCE DIRECT switch** (10)
- 8 BALANCE control knob** (10)
- 9 VOLUME control knob** (10)
- 10 SPEAKERS A/B switches** (10)
- 11 INPUT SELECTOR knob** (10)
- 12 Input indicator** (10)
- 13 Remote control sensor** (17)

NOTE

Functions **4**, **6** and **8** are only available when the **SOURCE DIRECT** switch is set to "OFF".



Rear panel

□ PMA-720AE

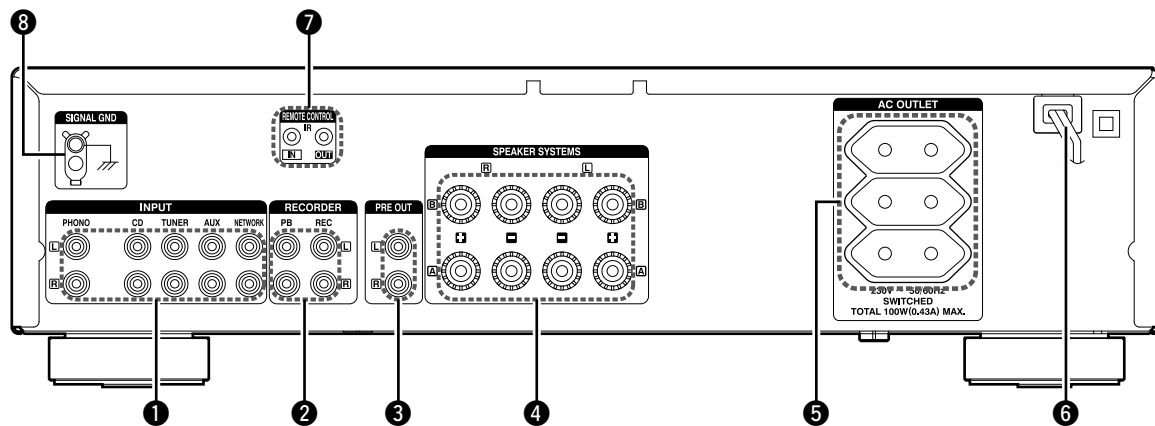

□ PMA-520AE

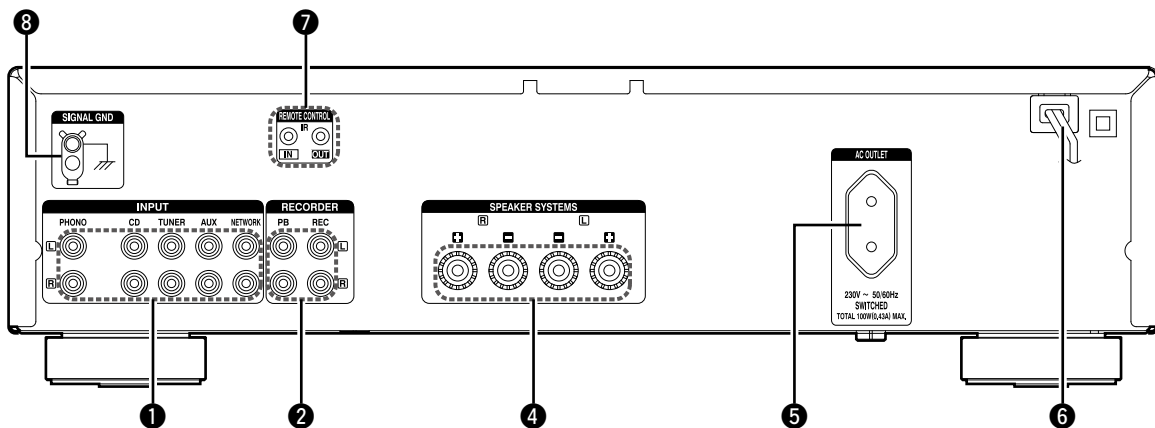

- 1 Input connectors (INPUTS) (4)
- 2 Input/output connectors (Recordings) (RECORDER) (10)
- 3 PRE OUT connectors (7)
- 4 Speaker system terminals (SPEAKER SYSTEMS) (4)
- 5 AC OUTLET (8)
- 6 Power cord (8)
- 7 REMOTE CONTROL jacks
Extension jack for future use. (8)
- 8 SIGNAL GND (ground) terminal (7)

NOTE

- This terminal is not a safety ground.
- The SIGNAL GND terminal of this unit is not a safety ground connection. Connect it to reduce noise when noise is excessive. Note that depending on the record player, connecting the ground line may have the reverse effect of increasing noise. In this case, it is not necessary to connect the ground line.



Remote control unit

This section explains the buttons used to playback each source.

AMP operation

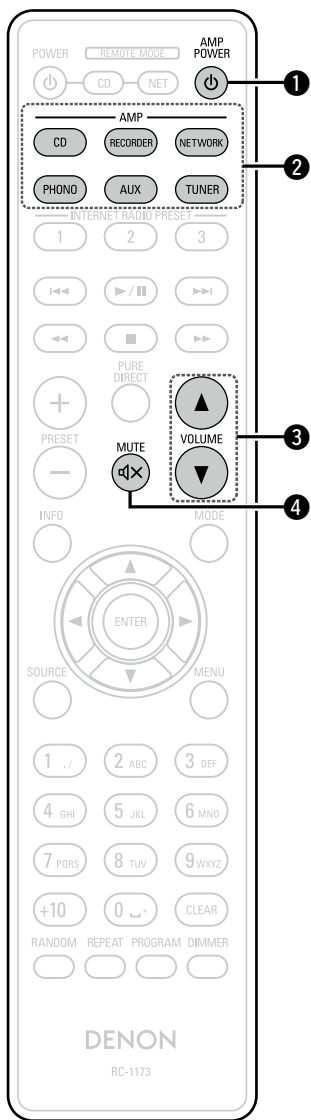

- 1 AMP POWER button (⏻) (10)
- 2 Input source select buttons (AMP) (10)
- 3 VOLUME buttons (▲▼) (10)
- 4 Muting button (MUTE ) (10)

CD operation

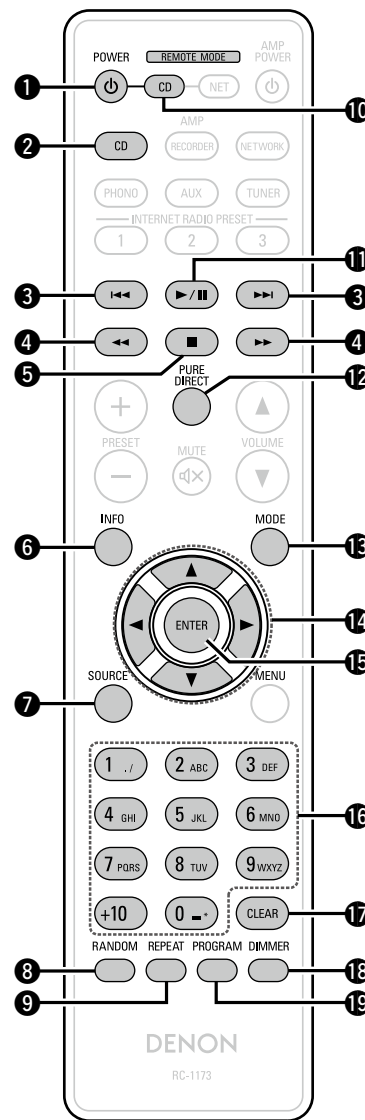

- 1 POWER button (⏻)
- 2 Input source select button (CD)
- 3 Reverse-skip/Forward-skip buttons (⏮, ⏭)
- 4 Fast-reverse/Fast-forward buttons (⏪, ⏩)
- 5 Stop button (■)
- 6 Information button (INFO)
- 7 SOURCE button
- 8 RANDOM button
- 9 REPEAT button
- 10 Remote mode select button (CD)
- 11 ▶/|| button
- 12 PURE DIRECT button
- 13 MODE button
- 14 Cursor buttons (▲▼◀▶)
- 15 ENTER button
- 16 Number buttons (0 - 9, +10)
- 17 CLEAR button
- 18 DIMMER button
- 19 PROGRAM button

Switching remote modes

To operate CD, press **CD** to switch the remote control to the CD operation mode.

- **CD** lights for approximately two seconds.



Operate the amplifier with the amplifier operation button even when the remote control operation mode is CD.



NETWORK operation

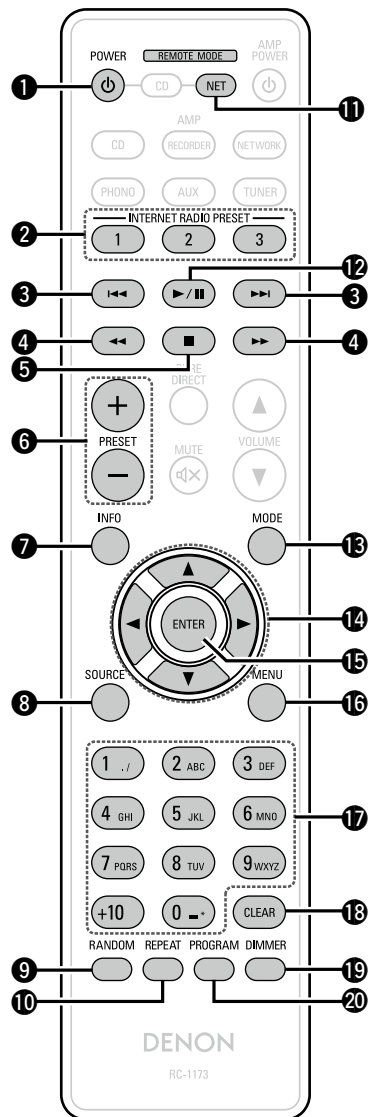

- ❶ POWER button (⏻)
- ❷ INTERNET RADIO STATION buttons (1 – 3)
- ❸ Reverse-skip/Forward-skip buttons (⏮, ⏭)
- ❹ Fast-reverse/Fast-forward buttons (⏪, ⏩)
- ❺ Stop button (■)
- ❻ PRESET buttons (+, -)
- ❼ Information button (INFO)
- ❽ SOURCE button
- ❾ RANDOM button
- ❿ REPEAT button
- ⓫ Remote mode select button (NET)
- ⓬ ▶/|| button
- ⓭ MODE button
- ⓮ Cursor buttons (⬆️⬇️⬇️⬆️)
- ⓯ ENTER button
- ⓰ MENU button
- ⓱ Number buttons (0 – 9, +10)
- ⓲ CLEAR button
- ⓳ DIMMER button
- ⓴ PROGRAM button

❑ Switching remote modes

To operate NETWORK, press **NET** to switch the remote control to the NETWORK operation mode.

- **NET** lights for approximately two seconds.



Operate the amplifier with the amplifier operation button even when the remote control operation mode is NETWORK.



Inserting the batteries

- Remove the rear lid in the direction of the arrow and remove it.
- Load the two batteries properly as indicated by the marks in the battery compartment.

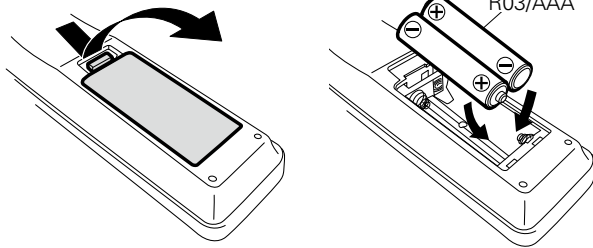

- Put the rear cover back on.

NOTE

- Insert the specified batteries in the remote control unit.
- Replace the batteries with new ones if the set does not operate even when the remote control unit is operated close to the unit. (The supplied batteries are only for verifying operation. Replace them with new batteries at an early date.)
- When inserting the batteries, be sure to do so in the proper direction, following the ⊕ and ⊖ marks in the battery compartment.
- To prevent damage or leakage of battery fluid:
 - Do not use a new battery together with an old one.
 - Do not use two different types of batteries.
 - Do not attempt to charge dry batteries.
 - Do not short-circuit, disassemble, heat or dispose of batteries in flames.
 - Do not keep the battery in a place exposed to direct sunlight or in places with extremely high temperatures, such as near a heater.
- If the battery fluid should leak, carefully wipe the fluid off the inside of the battery compartment and insert new batteries.
- Remove the batteries from the remote control unit if it will not be in use for long periods.
- Used batteries should be disposed of in accordance with the local regulations regarding battery disposal.
- The remote control unit may function improperly if rechargeable batteries are used.

Operating range of the remote control unit

Point the remote control unit at the remote sensor when operating it.

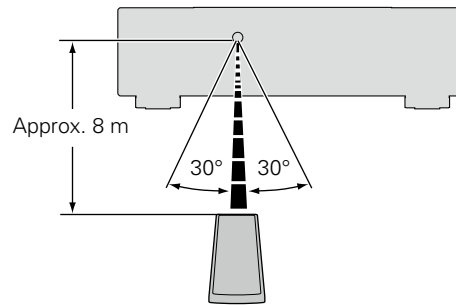

NOTE

- The set may function improperly or the remote control unit may not operate if the remote control sensor is exposed to direct sunlight, strong artificial light from an inverter type fluorescent lamp or infrared light.
- When using 3D video devices that transmit radio communication signals (such as infrared signals etc) between the various units (such as the monitor, 3D glasses, 3D transmitter unit etc), the remote control unit may not operate due to interference from those radio communication signals. If this occurs, adjust the direction and distance of the 3D communication for each unit, and check that the remote control unit operation is not affected by these signals.

Explanation terms

B

Bi-wiring connection (PMA-720AE only)

This method of connecting a speaker by using two speaker cables enables separate transmission of treble and bass signals. This enables playback with minimal interference between the high-range speaker unit and the low-range speaker unit.

P

Protection circuit

This is a function to prevent damage to components within the power supply when an abnormality such as an overload or excess voltage occurs for any reason. In this unit, the power indicator blinks and the unit enters standby mode when an abnormality occurs.

S

Source direct

Playback with higher fidelity to the source becomes possible, as input audio signals are output by bypassing the audio quality-control circuits (bass/treble/balance).

Speaker impedance

This is certain-rated resistance of the speaker set to an alternating current and expressed in ohms. The smaller the impedance, the greater the output. However, load on the amplifier is increased. Use speakers whose impedance is supported by this unit.





Troubleshooting



If a problem occurs, first check the following:

1. Are the connections correct?

2. Is the unit being operated as described in the owner's manual?

3. Are the other components operating properly?

If this unit does not operate properly, check the items listed in the table below. If the problem persists there may be a malfunction.

In that case, disconnect the power immediately and contact your retail outlet.

Symptom	Cause	Countermeasure	Page
When the power is turned on, the power indicator does not light and no sound is produced.	<ul style="list-style-type: none"> The power cord's plug is not fully plugged in. 	<ul style="list-style-type: none"> Check if the cord is securely inserted into the wall power outlet. 	8
Power switches off suddenly while you are using the unit, the power indicator will flash in red at intervals of approximately 1 seconds.	<ul style="list-style-type: none"> The protection circuit will be activated depending upon the temperature rise in the internal parts of the unit. 	<ul style="list-style-type: none"> Please switch off power at once, and re-apply the power after the body temperature has fallen sufficiently. Please re-install the unit in a place having good ventilation. 	5
Power switches off suddenly while you are using the unit, the power indicator will flash red at intervals of approximately 0.5 seconds.	<ul style="list-style-type: none"> A speaker with impedance not supported by this unit is used. The protection circuit has been activated because the core wires of different speaker cables have touched each other or a core wire was slipped out of the terminal and is touching the unit's rear panel. 	<ul style="list-style-type: none"> Please use speakers which have the specified impedance. Unplug the power cord, then after twisting the core wires together tightly again, or effecting termination treatments etc, please reconnect once again. 	5 4
Even applying power, the power display flashes red at intervals of approximately 0.5 seconds.	<ul style="list-style-type: none"> The amplifier circuit has failed. 	<ul style="list-style-type: none"> Switch off the power and please contact the DENON service adviser. 	-

Symptom	Cause	Countermeasure	Page
The power indicator lights but no sound is produced.	<ul style="list-style-type: none"> The speaker cables are not fully connected. The device you want to listen to has not been selected. The volume control is set to minimum. The input cable is not fully connected. 	<ul style="list-style-type: none"> Connect securely. Insure the correct input is selected. Set to an appropriate level. Connect securely. 	5, 6 10 10, 13 13
Sound is only produced from the left or right speaker (s).	<ul style="list-style-type: none"> The speaker cables are not fully connected. The input cable is not fully connected. The left/right balance is off. 	<ul style="list-style-type: none"> Connect securely. Connect securely. Adjust to a proper balance with the balance control knob. 	4, 5, 6 5, 6 10
The left and right of stereo sound is reversed.	<ul style="list-style-type: none"> The connections of the speakers or input cables are reversed. 	<ul style="list-style-type: none"> Check the connections to be sure that left is connected to left, right to right. 	5, 6
Humming sound is heard in the music when playing records.	<ul style="list-style-type: none"> The player's ground wire is not connected. The cables are not fully connected to the PHONO terminals. Influence from a TV or VCR near the player. 	<ul style="list-style-type: none"> Connect securely. Connect securely. Try changing the positions in which the devices are installed. 	7 7 -
Howling is produced along with the music if the volume is too high when playing records.	<ul style="list-style-type: none"> The player and speakers are too close together. The vibrations from the speakers are being transmitted to the player through the floor. 	<ul style="list-style-type: none"> Install the player and speakers as far from each other as possible. Use cushions, etc., to absorb the speakers' vibrations. 	- -
When playing a record, the sound is distorted.	<ul style="list-style-type: none"> The needle pressure is incorrect. There is dirt on the tip of the needle. The cartridge is defective. 	<ul style="list-style-type: none"> Adjust to a proper needle pressure. Check the tip of the needle. Replace the cartridge. 	- - -



Specifications

❑ PMA-720AE

❑ Power amplifier section

Rated output power: 2-channel driving (CD → SP OUT)
50 W + 50 W (8 Ω, 20 Hz – 20 kHz, T.H.D. 0.07 %)
85 W + 85 W (4 Ω, DIN, 1 kHz, T.H.D. 0.7 %)

Dynamic power: 85 W + 85 W (4 Ω, DIN, 1 kHz, T.H.D. 0.7 %)

Total harmonic distortion: 0.01 % (Rated output: –3 dB), 8 Ω, 1 kHz

Output terminals: Speaker A or B: 4 – 16 Ω
A + B: 8 – 16 Ω
Suited for headphones/stereo headphones

❑ Pre amplifier section

PREOUT output: 0.7V

**Equalizer amplifier output:
(REC OUT terminals)** 150 mV

Input sensitivity/Input impedance: PHONO (MM): 2.5 mV/47 kΩ
CD, TUNER, AUX, Network, RECORDER:
110 mV / 30 kΩ (SOURCE DIRECT OFF)
110 mV / 16 kΩ (SOURCE DIRECT ON)

RIAA deviation: PHONO (MM): 20 Hz – 20 kHz±0.5 dB

❑ Overall performance

S/N (IHF-A weight): PHONO (MM): 86 dB
(With input terminals short-circuited, 5 mV input signal)
CD, TUNER, AUX, Network, RECORDER:
107 dB (input terminals short-circuited)

Tone control: BASS: 100 Hz±8 dB
TREBLE: 10 kHz±8 dB

Loudness: 100 Hz: +6 dB, 10 kHz: +6 dB

❑ General

Power supply: AC 230 V, 50/60 Hz

Power consumption: 200 W

Power consumption in standby mode: 0.3 W

Power outlets: 3 switched outlets, total capacity 100 W (0.43 A)

* For the purpose of improvement, the specifications and design are subject to change without notice.

❑ PMA-520AE

❑ Power amplifier section

Rated output power: 2-channel driving (CD → SP OUT)
45 W + 45 W (8 Ω, 20 Hz – 20 kHz, T.H.D. 0.07 %)
70 W + 70 W (4 Ω, DIN, 1 kHz, T.H.D. 0.7 %)

Dynamic power: 70 W + 70 W (4 Ω, DIN, 1 kHz, T.H.D. 0.7 %)

Total harmonic distortion: 0.02 % (Rated output: –3 dB), 8 Ω, 1 kHz

Output terminals: Speaker: 4 – 16 Ω
Suited for headphones/stereo headphones

❑ Pre amplifier section

**Equalizer amplifier output:
(REC OUT terminals)** 150 mV

Input sensitivity/Input impedance: PHONO (MM): 2.5 mV / 47 kΩ
CD, TUNER, AUX, Network, RECORDER:
110 mV / 30 kΩ (SOURCE DIRECT OFF)
110 mV / 16 kΩ (SOURCE DIRECT ON)

RIAA deviation: PHONO (MM): 20 Hz – 20 kHz±0.5 dB

❑ Overall performance

S/N (IHF-A weight): PHONO (MM): 84 dB
(With input terminals short-circuited, 5 mV input signal)
CD, TUNER, AUX, Network, RECORDER:
105 dB (input terminals short-circuited)

Tone control: BASS: 100 Hz±8 dB
TREBLE: 10 kHz±8 dB

Loudness: 100 Hz: +6 dB, 10 kHz: +6 dB

❑ General

Power supply: AC 230 V, 50/60 Hz

Power consumption: 185 W

Power consumption in standby mode: 0.3 W

Power outlet: 1 switched outlets, total capacity 100 W (0.43 A)

* For the purpose of improvement, the specifications and design are subject to change without notice.



Index

A	Adjust the tone.....	10
	Auto Standby mode	11
B	BALANCE	13
	BASS	13
	Batteries	17
	Bi-wiring	6, 17
C	Cable	
	Audio cable	4
	Speaker cable	4
	Cables used for connections	4
	Connection	
	Player	7
	Power cord	8
	Pre out jacks (PMA-720AE only)	7
	Recorder	8
	Speaker	4
I	INPUT SELECTOR.....	10
L	LOUDNESS	11
M	Mute.....	10
P	Power cord.....	8
	Protection circuit	5, 17
R	Remote control unit	15
S	Source direct	17
	SOURCE DIRECT	10
	Speaker impedance.....	5, 17
	SPEAKERS A/B	13
	Speakers cable	4

T	TREBLE	13
V	VOLUME	13

Dimensions

