



**AVAILABLE AT  
DIGITAL CINEMA**

---

KEF R&D

KC62

---

# CONTENTS

2	<b>Introduction</b>
2	<b>Philosophy</b>
2	<b>KC62</b>
2	Compact Subwoofers
2	Hofmann's Iron Law
3	<b>Technology</b>
3	<b>Uni-Core Driver Array</b>
3	Force Cancelling/Dual Voice Coils
4	Matching Driver Behaviour
5	Inductance
6	<b>P-Flex Surround</b>
7	<b>Smart Distortion Control Technology</b>
7	Hybrid Control Systems
8	<b>Aluminium Cabinet</b>
8	Vibration Control
8	Thermal Management
8	<b>Frequency Response</b>
9	<b>Conclusion</b>
9	<b>References</b>
10	<b>Specifications</b>



*KC62 front (Mineral White finish, top) and side (Carbon Black finish, bottom)*

# Introduction

Designing a small, high-performance subwoofer is difficult. There are compromises to be made in regards to output and extension.

With the KC62 Uni-Core subwoofer, KEF engineers have developed three new patent-pending technologies that work together to deliver a higher level of performance in all aspects at the form factor.

This paper discusses these new technologies, and other features, as well as giving insight into KEF's philosophy on subwoofer and loudspeaker design.

## Philosophy

*"Of all art, music is the most indefinable and the most expressive, the most insubstantial and the most immediate, the most transitory and the most imperishable. Transformed to a dance of electrons along a wire, its ghost lives on. When KEF returns music to its rightful habitation, your ears and mind, they aim to do so in the most natural way they can... without drama, without exaggeration, without artifice"*

Raymond Cooke OBE, KEF Founder

These words were penned shortly after KEF's founding in 1961. Cooke was an avid music lover and his mission from the outset was to enable a wide audience to derive the same pleasure from music as he did. He sought to deliver to his customers the immersive experience of the live performance through recordings.

Cooke realised that this could only be achieved by a scientific understanding of sound and its reproduction, concentrating his efforts on loudspeakers - the last link in the chain and probably the most difficult, in that they have to work in an unknown three-dimensional environment. Never afraid to employ the most capable engineers and provide them with the latest and most effective tools, Cooke established an engineering philosophy that still exists today.

KEF engineers continue to pursue this scientific endeavour, using tools and technology that were

unavailable to Cooke in those early days. The listening experience is still the final arbiter in deciding whether or not the science is effective, but without it progress cannot be measured and the way forward cannot be understood.

## KC62

KC62 is the smallest force-cancelling subwoofer KEF has ever developed. It aims to push the idea of Hofmann's Iron Law to its limits. Brand new technologies and features work together to produce a novel system that delivers on all three fronts - high output, low extension and small cabinet size. When combined with KEF's thorough understanding of driver design, KC62 provides all of this with finesse, delivering detail and impact precisely when required.

## Compact Subwoofers

There are four main reasons why somebody may prefer to choose a compact subwoofer:

- Smaller listening area
- Placement in a dual-purpose room, for example a living room
- Aesthetic consideration
- Easier to accommodate multiple subwoofers

However, the size of compact subwoofers introduces certain compromises.

## Hofmann's Iron Law

Josef Anton Hofmann described the relationship between three parameters in loudspeaker design - cabinet volume, low frequency extension and efficiency. His Iron Law states that, of these three, one must be compromised in order to achieve favourable results in the other two. Various papers have further discussed the related loudspeaker parameters [1][2][3].

Consider the modern string family of musical instruments - the violin, viola, cello and double bass. Table 1 shows the lowest notes that these instruments will play in their standard tuning, along with the frequency of that note - the violin being the highest pitch, through to the double bass as the lowest.

It should also be noticed that the size of the instrument increases as the frequency of the lowest note it can reproduce decreases (Figure 1). It would be possible to make a double bass with a smaller body - but it would be far, far quieter.

The same occurs with subwoofers.

Instrument	Lowest Note	Frequency
Violin	G3	196 Hz
Viola	C3	130.8 Hz
Cello	C2	65.4 Hz
Double Bass	E1	41.2 Hz

Table 1. Lowest frequencies typically produced by members of the modern string family of instruments



Figure 1. Violin and Double bass

When designing a small subwoofer, the choice has to be made between high efficiency and low frequency extension. Both are very desirable features for a subwoofer.

Why the term 'Iron Law'? Goethe, in the poem *Das Göttliche*, refers to 'great, eternal iron laws.' Iron is strong, everlasting, and never to be broken.

To create a subwoofer that can deliver the maximum performance for the minimum of space, KEF R&D worked to push the compromises as far as possible.

After all, Iron Laws cannot be broken, but they can certainly be bent.

## Technology

### Uni-Core Driver Array

Uni-Core is a brand new, patent-pending driver design that combines high excursion and force cancelling whilst reducing size - ideal for pushing the boundaries of ultracompact subwoofer performance.

### Force Cancelling/Dual Voice Coils

KEF has considerable experience with force cancelling, having released subwoofers such as KF92, and Reference 8b, as well as the world's first Single Apparent Source loudspeaker, Blade. What may be less well-known, however, is that KEF actually launched the first commercial loudspeaker with force cancelling all the way back in 1984 - the Reference 104/2 (Figure 2).

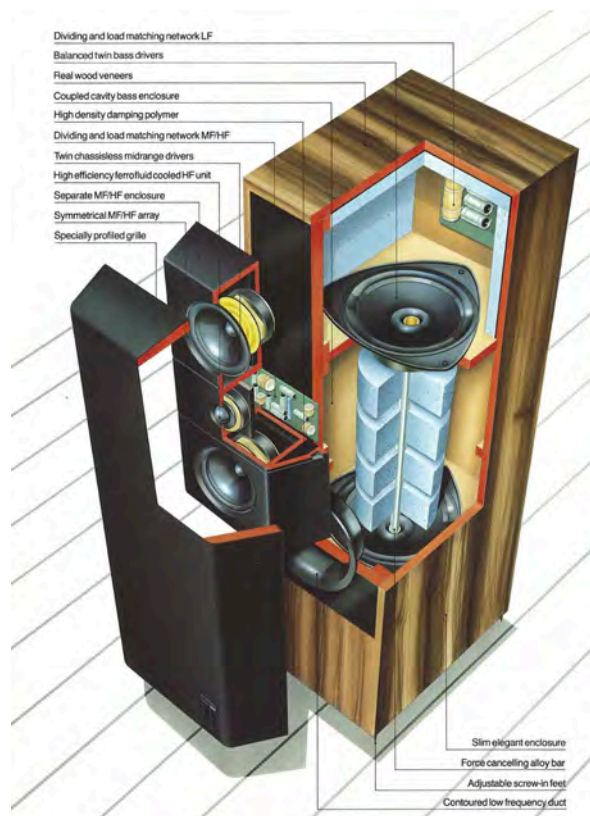

Figure 2. Reference 104/2 - the internal twin bass drivers were braced using a metal rod, allowing for a force cancelling arrangement

Force cancelling provides two major benefits - firstly, as driver motion exhibits Newton's Third Law -every action has an equal and opposite reaction - the driver's motion causes mechanical vibration in the cabinet. Having an identically performing driver placed in opposition cancels out the reaction force of each driver - hence the term 'force cancelling.' This greatly reduces cabinet vibration, and in turn reduces sound coloration. Secondly, the doubling of cone area increases the maximum output of the subwoofer by up to 6dB.

Force cancelling can be achieved by mounting, or bracing, two opposing drivers back to back. This will dictate the depth of the cabinet. To achieve reduced depth, driver excursion must be reduced, compromising maximum output.

Uni-Core, however, is not comprised of two drivers mounted back to back. Instead, the two voice coils are arranged within a single motor system (Figure 3).

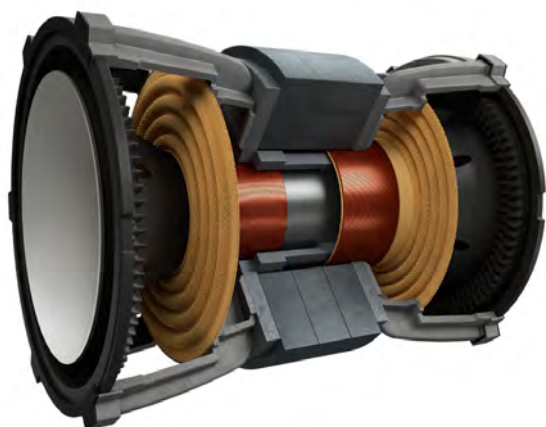

Figure 3. Cutaway of the Uni-Core driver array

The two voice coils have different diameters, allowing one to be placed concentrically within the other. This arrangement allows the voice coils to travel within their own gap without colliding. With increased maximum excursion, higher sound pressure levels can be achieved (Figure 4).

Figure 5 compares the magnetic flux paths in a conventional back-to-back arrangement of two driver motors against the KC62 Uni-Core motor. In the traditional arrangement, two paths can be seen, one for each voice coil gap, whilst with Uni-Core, a single path crosses both voice coil gaps.

To achieve force cancelling, one voice coil in the Uni-Core arrangement has been wired in inverse polarity due to the shared magnetic flux direction.

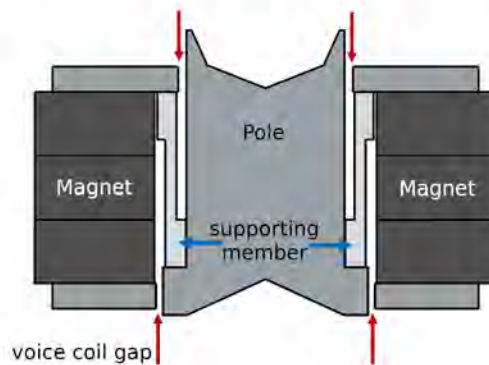

Figure 4. Schematic of the Uni-Core driver motor

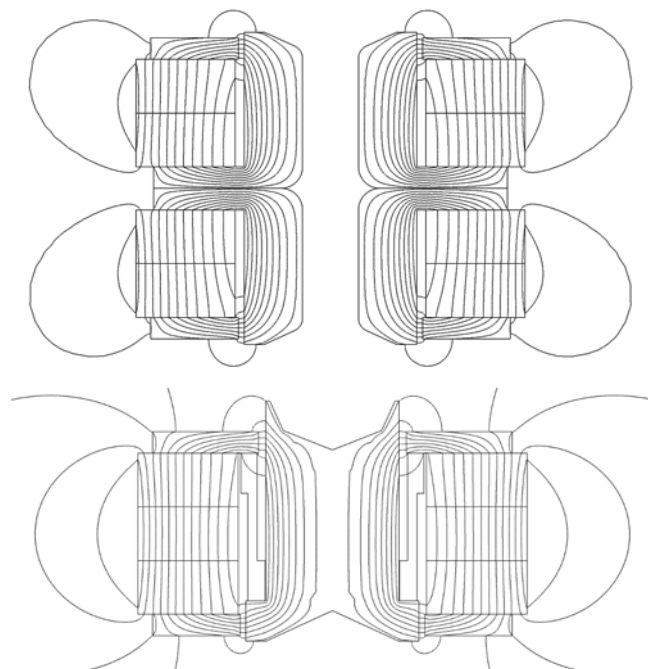

Figure 5. Magnetic FEA simulation of the flux paths of two opposing motor systems (top) and Uni-Core with a single motor system and two gaps (bottom)

## Matching Driver Behaviour

Clearly, the two component drivers of Uni-Core are not physically identical, but, for force cancelling to work, both have been designed to perform equally.

From the onset, three areas were highlighted - the BL (motor force factor), the stiffness of the suspension, and the moving mass must all be consistent across both drivers. The first two are also functions of cone displacement.



BL is the product of the magnetic flux density in the voice coil gap (B) and the length of wire in the gap (L). In Uni-Core, the larger diameter voice coil has a larger amount of wire in the gap. However, the structure of Uni-Core naturally accounts for this.

In the single motor system design of Uni-Core, both sides have approximately the same magnetic flux passing radially through the motor gap. However, due to the different coil diameters, the area through which the flux passes is different. This means that the flux density (B) in the small gap is greater by approximately the ratio of the coil diameters. This allows the BL of both drivers to match across the whole driver excursion (Figure 6).

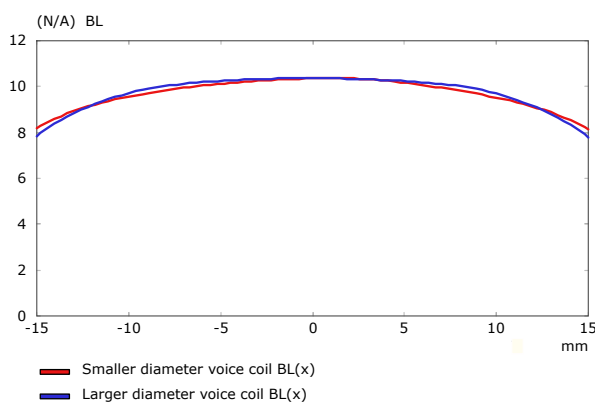

Figure 6. Comparison of BL(x) for the two voice coils in Uni-Core

In regards to the suspension stiffness, KEF engineers carried out Finite Element Analysis (FEA) [4] to develop two different suspensions which behave identically, even though they are attached to voice coil formers of different diameters.

Additionally, the driver with the smaller diameter voice coil has a small mass added to it to compensate for the higher mass of the larger diameter voice coil in the opposing driver.

## Inductance

The Uni-Core arrangement places two voice coils in close proximity to one another, and with the same current orientation during use. In addition, as the voice coils move, their relative separation is constantly changing. A major concern during the development of the technology was the effect this would have on both the self and mutual inductance of the two coils.

Inductance is a critical aspect of all high performance loudspeaker drivers. The self-inductance of the voice coil determines how much magnetic field is generated as electrical current flows in the windings. Excess inductance results in a strong magnetic field being generated by the voice coil, and this can result in modulation of the permanent magnetic field of the motor leading to distortion. In addition, with a typical motor system the coil inductance varies depending on the cone position. This results in an unwanted force on the coil, called the reluctance force, which pulls the loudspeaker cone towards the location where the inductance is highest [5]. The reluctance force is proportional to the square of the electrical current and is hence highly non-linear.

In addition to the self-inductance, in the Uni-Core the mutual inductance of the two coils must be considered too. Mutual inductance measures the ability of current in one voice coil to generate a magnetic field which interacts with a second coil. In a sense, it is a measure of the cross-talk between the coils. Since Uni-Core is designed to be operated with both coils driven in parallel, signal cross-talk is not the primary concern, but rather that if the magnitude of mutual inductance varies depending on the separation of the coils then this could give rise to additional non-linearities.

At the outset of the technology development the inductance behaviour of Uni-Core was one of the major concerns. To understand the inductance behaviour in detail, a series of numerical simulations were carried out. This study revealed some surprising, and unexpected, characteristics of the arrangement, which are summarised in Figure 7. Shown are three curves of inductance versus frequency for three different motor arrangements. These results are not specifically for the KC62 driver but they are comparable with one another and typify the characteristics of the motor geometries.

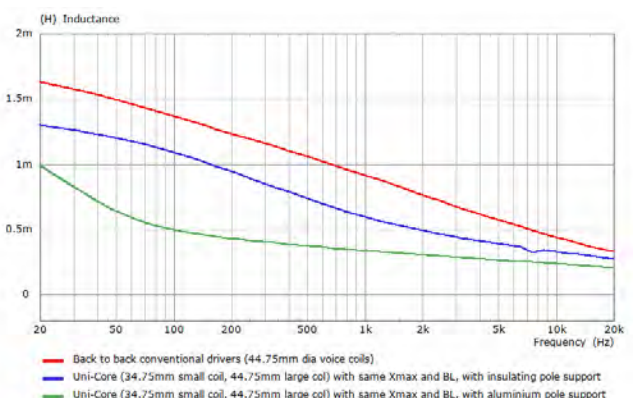

Figure 7. Inductance comparison of Uni-Core with an equivalent conventional motor

The red curve shows the inductance of a pair of parallel-connected back-to-back conventional drivers with a simple ring ferrite motor and no aluminium or copper conductive rings, and with the coil held at the rest position. The inductance is plotted against frequency and is maximum at low frequencies, then reduces as frequency increases due to the effect of eddy currents flowing in the motor steelwork. The conventional result may be compared with the blue curve, which shows the inductance for a simple Uni-Core configuration, again without any conductive rings.

The surprising result is that the Uni-Core inductance is lower. The reason that this is surprising is because instinctively, a loudspeaker engineer would expect the total inductance to be higher because of the mutual inductance in the Uni-Core, which is not present in the two conventional drivers. Other dual gap motor systems are in use by other manufacturers and one of the most common arrangements is the "Differential Drive" arrangement invented by JBL shown in Figure 8. This arrangement is known to have favourable inductance characteristics and it is commonly commented that this results from the cancellation effect of the two voice coils, which in this case carry current in opposite directions. In fact, the improved inductance is largely due to the influence of the second magnetic gap in the motor system [6].

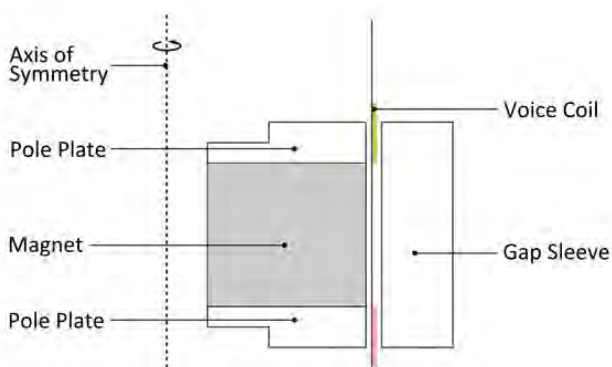

Figure 8. Lumped circuit representation of a single driver, dual voice coil system

Uni-Core has lower inductance for the same reason – the magnetic circuit of the motor system has a higher reluctance than a conventional motor due to the additional gap for the second coil. This reduces the inductance amplifying effect of the motor system steelwork.

In a Uni-Core motor the central steel pole is located

inside both coils and a supporting member is needed to hold this in place (Figure 4). The Uni-Core uses a large aluminium cylinder placed between these coils to serve this purpose. The material and geometry of the member is an important design parameter. From an inductance perspective it acts as a large, low-resistance, shorted turn in close proximity to both coils. The result is to dramatically drop the total inductance and the total-inductance variation with the location of the coils. The green line in Figure 7 shows this effect, and compared to the conventional motors the inductance is very significantly reduced. After more detailed analysis it was found that this aluminium cylinder can be used to decrease the mutual inductance of the two coils.

The aluminium cylinder also has an important role in the power handling of the Uni-Core motor, adding vital thermal mass near the voice coils and helping to conduct heat away from the interior of the motor.

## P-Flex Surround

In a sealed cabinet, when a loudspeaker diaphragm moves in and out, the internal air volume compresses and expands. The number of air molecules within does not change, however.

What does change is air pressure - increasing when the driver moves inwards, and decreasing when the driver moves outwards. This is because an enclosed volume of air is always seeking to achieve equilibrium with the surrounding environment. As a result, the entire interior surface of the cabinet and drivers experience a pressure force in opposite polarity to the driver motion.

As the driver moves inwards, the air pressure inside increasingly pushes against the driver. The opposite occurs when the driver moves outwards. In a very small box, the restoring force of the air has a non-linear effect, with the outward force when the driver moves inward exceeding the force when the driver moves outward. This results in nonlinear distortion.

Another important consideration is how this pressure force affects the performance of the driver surround. With a conventional half roll surround, high pressure can deform the surround causing it to buckle (Figure 9). This leads to gross distortion.





Figure 9. Cross-section of half roll type surround buckling at high excursion

A conventional solution to this problem is to use a very thick surround. However, this has two negative effects. Firstly the surround mass is substantially increased leading to a lower efficiency. Secondly, the stiffness of the surround is increased, dramatically compromising the low frequency extension of the driver.

The P-Flex surround is a patent-pending, pressure resistant surround consisting of a pleated design (Figure 10). The shape is optimised to resist the deformation caused by the changing internal air pressure of the cabinet, whilst allowing extended, linear movement of the driver, without the issue of buckling at higher excursion.

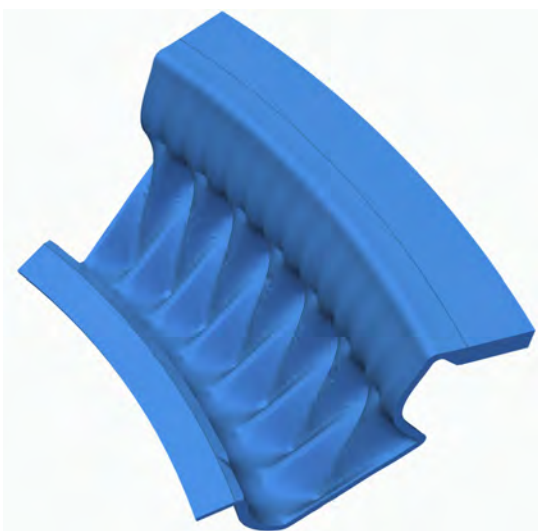

Figure 10. Cross-section of P-Flex surround at high excursion showing folded detail and no buckling

## Smart Distortion Control Technology

There are numerous mechanisms whereby distortion is introduced into the radiated sound. An ideal loudspeaker would exhibit the following:

- $BL(x)$  stays the same at all coil positions
- The stiffness of the suspension is consistent across the excursion
- The stiffness of the internal air volume does not change as the driver moves back and forth
- Voice coil inductance should not modulate with coil position

During the component design stage of KC62, the variation in these parameters has been reduced as far as possible. To achieve further reduction of distortion, KC62 incorporates a patent pending active control system. This is a key contributor to its performance, and a major reason for the breakthrough for this ultra-compact subwoofer.

## Hybrid Control System

Smart Distortion Control Technology (SDCT) is a hybrid system combining DSP pre-correction with indirect cone motion sensing and feedback. These two component systems are specifically designed to work together, each tackling different distortion mechanisms (Figure 11).

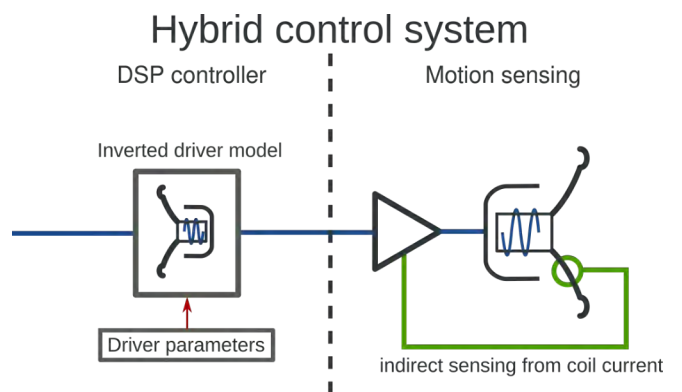

Figure 11. Representation of the Hybrid Control System

The DSP portion of the system uses an inverted numerical model of the loudspeaker, pre-programmed with the driver parameters, which pre-corrects the DSP output signal such that the added distortion counteracts distortion generated by the drivers. Simultaneously the instantaneous cone motion is indirectly sensed from the electrical current in the driver coils, and this signal is used in a feedback loop within the amplifier electronics.

In addition, the Uni-Core driver is specifically designed to maximise the performance of SDCT - achieving a reduction in THD of up to 75% (Figure 12).

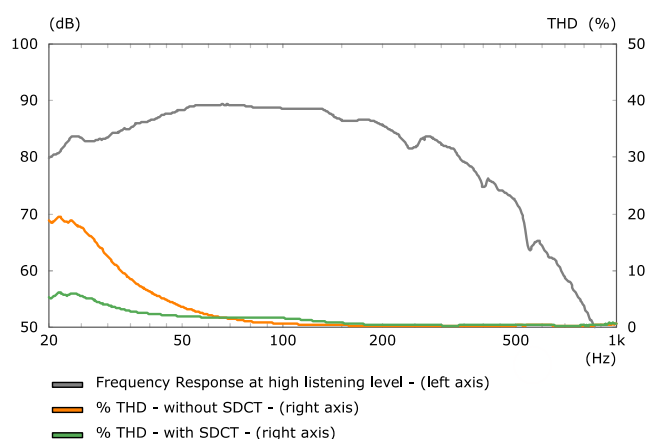

Figure 12. THD(%) comparison (right axis) against frequency of KC62 with and without SDCT

## Aluminium Cabinet

### Vibration Control

The issue of internal air pressure has already been discussed in the P-Flex surround section of this paper. However, there is another mechanism wherein the substantial pressure forces within the cabinet will attempt to equalise - by flexing the walls. As a vibrating surface this would cause sound coloration.

With this in mind, an extruded aluminium cabinet was designed. As aluminium has a higher elastic modulus than wood for a given thickness, the use of a thinner wall was possible. This provides a larger internal acoustic volume for the given external dimensions.

The aluminium extrusion is shaped as a curved shell. Curved surfaces are significantly more rigid than flat ones, and having a monocoque construction ensures there are no stress points, which would otherwise compromise the cabinet integrity.

The additional strength afforded also eliminated the need for internal bracing, further increasing the available air volume inside the cabinet.

## Thermal Management

A small cabinet needs an exceptional amount of power in order to help deliver bass depth and output - after all, Hofmann's law cannot be broken. The trade-off, however, is through heat build-up. Both amplifiers and loudspeakers are not 100% efficient, meaning any power not converted to radiated sound is converted into heat. So while KC62 needs to have a significantly powerful amplifier, considerations must be made to avoid heat buildup.

Power is provided by a pair of 500W RMS Class-D amplifiers - each one driving a single voice coil. Class-D is a highly efficient topology, ideal for active subwoofers as less heat is produced. The heat dissipated by the drivers is also carefully managed by the cabinet - aluminium makes for an excellent heatsink, and has been carefully designed to ensure effective heat dissipation.

## Frequency Response

Through these new technologies, KC62 exhibits an exceptionally wide and deep frequency response, especially for a subwoofer that is barely larger than a football. Figure 13 shows the frequency response at 1 metre, at several listening levels. Also included are additional dotted lines, showing the in-room frequency response. This takes into account the low frequency enhancement in a typical room.

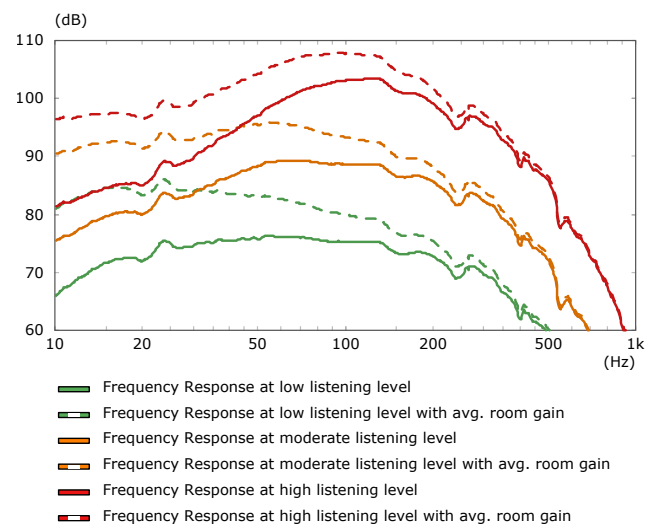

Figure 13. Frequency Response for low, medium and high listening levels, both anechoic and with room gain

## Conclusion

Through significant new technological advancements and considered engineering, KC62 delivers an unprecedented combination of depth, detail and output from an ultracompact form. By pushing the boundaries of what has been considered possible, KEF offers a way for almost anybody with any system, in almost any room to benefit from what a well-designed and integrated subwoofer can bring to both music and film - the complete experience, just as the artist intended.

## References

- [1] J. Wright, 'Finite Element Analysis as a Loudspeaker Design Tool', presented at the Audio Engineering Society UK 13th Conference; Microphones and Loudspeakers, Mar. 1998. [Online] Available: <http://www.aes.org/e-lib/browse.cfm?elib=7992>
- [2] R. Small, 'Closed-Box Loudspeaker Systems-Part One: Analysis', JAES Volume 20 Issue 10 pp. 798-808 Dec. 1972 Available: <http://www.aes.org/e-lib/browse.cfm?elib=2022>
- [3] R. Small, 'Vented-Box Loudspeaker Systems-Part 1: Small-Signal Analysis', JAES Volume 21 Issue 5 pp. 363-372 Jun. 1973 Available: <http://www.aes.org/e-lib/browse.cfm?elib=1967>
- [4] J. Ocle-Brown, 'Loudspeaker Compression-Driver Phase-Plug Design', University of Southampton, Faculty of Engineering and the Environment, Nov. 2012, PhD Thesis Available: <https://eprints.soton.ac.uk/348798/1/Jack%2520Ocle-Brown%2520PhD%2520Thesis.pdf>
- [5] L. Risbo, F. T. Agerkvist, C. Tinggaard, M. Halvorsen, and B. Putzeys, 'Force Factor Modulation in Electro Dynamic Loudspeakers', presented at the Audio Engineering Society Convention 141, Sep. 2016, Accessed: Oct. 26, 2017. [Online]. Available: <http://www.aes.org/e-lib/browse.cfm?elib=18411>
- [6] F. Kochendörfer and A. Voishvillo, 'Comparative Static and Dynamic FEA Analysis of Single and Dual Voice Coil Midrange Transducers', presented at the Audio Engineering Society Convention 139, Oct. 2015, Accessed: Jan. 22, 2021. [Online]. Available: <https://www.aes.org/e-lib/browse.cfm?elib=17971>

## Specification

Model	KC62
Design	Uni-Core Force Cancellation
Drive units	2 x 6.5 in.
Frequency response	11Hz - 200Hz
Max output	105dB
Amplifier type	Built-in Class-D
Amplifier power	1000W RMS (2 x 500W RMS)
Variable low pass filter	40Hz - 140Hz, LFE
Input	RCA Phono sockets Speaker level inputs
Line output	RCA phono sockets
Line output high pass filter	40Hz - 120Hz, Bypass
Power requirements	100 - 240V ~50/60Hz
Power consumption	1000W
Weight	14kg (30.9lbs)
Dimensions (H x W x D) with rear panel and feet	246 x 256 x 248 mm (9.68 x 10.07 x 9.76 in.)



Control panel of KC62



KC62, Carbon Black

