

**MODELS**

**RS 6**

**GRANITE**



**RS 6**

**SANDSTONE**



**RS 6**

**CORAL**



Weatherproof Rock Loudspeaker



**AVAILABLE AT  
DIGITAL CINEMA**



# CONGRATULATIONS

Thank you for choosing a Rock Loudspeaker from Niles. With proper installation and operation, you'll enjoy years of trouble free use.

Niles' manufacturers the industry's most complete line of custom installation components and accessories for audio/video systems. For a free full line catalog write to: **Niles, Catalog Request, P.O. Box 160818, Miami, FL 33116-0818** or check our website at **[www.nilesaudio.com](http://www.nilesaudio.com)**.

## TABLE OF CONTENTS

INTRODUCTION	2
FEATURES & BENEFITS	3
INSTALLATION CONSIDERATIONS	5
INSTALLATION	10
OPERATION	17
SPECIFICATIONS	18
WARRANTY REGISTRATION CARD	21
LIMITED WARRANTY	22

## INTRODUCTION

The RS6 series of weatherproof rock loudspeakers are designed to provide unparalleled listening satisfaction and GeoRealistic™ styling. The extraordinary sonic performance of the **RS6** was achieved by harmonizing Niles' unique and proprietary technology with advances in cabinet assembly techniques. They are designed and built to withstand the environmental stresses placed on an outdoor loudspeaker. They will sound good and look good no matter what Mother Nature does to them.

The **RS6** series Loudspeaker is a two-way loudspeaker in an acoustic suspension enclosure. The cabinet is styled to look like a rock. It is supplied with a security bracket and cable to insure it stays where it is placed, reducing the chance of theft and unauthorized movement of the loudspeaker. For the first time, serious listeners will be able to enjoy the music in their backyard as much as their living room and the speakers will blend into the landscaping.



## FEATURES & BENEFITS

### GeoRealistic™ Styling

Traditionally, rock speakers have looked like ornaments and not like rocks. Each **RS6** style has unique textures and colors that are fashioned after natural rocks. Shaped grilles match the features on the front of the rock, making them blend into the cabinet. All of this extra attention to detail leads to a GeoRealistic™ style that enables the **RS6** to blend in with other landscaping and disappear. All that will be noticed is the great sound not the loudspeaker.

### Weather Proof Construction

The cabinet is made from fiberglass, it utilizes double seals on the tweeter, woofer and enclosure cover, the woofer drains water away from it, the grilles are painted aluminum and the drivers are made from weather resistant materials. The **RS6** has passed the most stringent environmental tests devised. Surviving over 5 years worth of temperature cycling and still having seals that pass a 24-hour submersion test. It has passed the test requirements for Salt Fog, Operating Temperature, Storage Temperature, UV Exposure and Humidity per military standard 883. Whether you are considered about salt-air, rain, freezing rain, snow, extreme temperatures, high humidity, direct sunlight or combinations of these conditions, the **RS6** has proven itself to withstand the harshest conditions Mother Nature can throw at it.

### 6.5" Injection Molded TCC Woofer

The unusually stiff and light injection molded TCC (talc, carbon, and ceramic) filled polypropylene cone, the butyl rubber surround, and the substantial magnet and motor structure are optimized for large excursions of the woofer. In this way, the 6-1/2" woofer can create superior bass output. In the end, the woofer design provides deep rich bass and outstanding weather resistance capabilities.

### 1" Teteron Tweeter

In the past, rock speakers have used a co-axial tweeter design that has disappointed listeners with a fatiguing and harsh treble sound caused by tweeter ringing. The **RS6's** 1" Teteron tweeter utilizes a tri-laminate design consisting of an inner textile layer which forms the dome, a high damping layer to kill unwanted resonances and an outside layer of urethane to add stiffness and prevent breakup modes. The result is a transparent clear, sweet, natural sounding tweeter, which still maintains its extended frequency response.

### Tweeter Placement Improves Coverage and Dispersion

The Tweeter is angled twenty degrees up from the woofer. This means that it is "aimed" at the listener and not at the ground. This improves the high frequency coverage of the loudspeaker and ensures that all the benefits of the 1" Teteron Tweeter are heard and not lost in the surroundings.

### **Precision Crossover**

A customized electronic dividing network inside the cabinet precisely distributes the music to the woofer and the tweeter. The three-pole two-way design of the **RS6** crossover provides excellent stereo imaging, low distortion and superior sonic performance.

### **ConeForward™ Design**

Most competitive rock speaker manufacturers mount their drivers from inside the cabinet. This moves the front of the driver inside the cabinet creating a tunnel for the driver to play through. This tunnel adversely affects the sound quality of the loudspeaker by making the loudspeaker sound "narrow" and "far away". Niles' engineers have used a patent-pending ConeForward™ design technique that moves the woofer and tweeter as close to the grille as possible. Combining the ConeForward™ design technique with tight quality control leads to unparalleled sonic performance and imaging from an outdoor rock loudspeaker.

### **Rigid Acoustically Inert Cabinet Construction**

Niles' utilizes a unique 4-layer cabinet construction to achieve superior non-resonance of the loudspeaker cabinet. This insures that all you hear is the music not the cabinet ringing.

### **Low Diffraction Microperf™ Aluminum Grilles**

The aluminum Microperf™ grille on the **RS6** has hundreds of precisely sized perforations, creating an acoustically transparent grille. The aluminum construction resists oxidation enabling years of trouble-free operation in the harshest conditions. We paint both sides of the grille for added protection.

### **Connection Cable with Water Resistant Wire Nuts**

Connecting the loudspeaker's cable to the cable running from the house is always a point of concern for the installer. If this connection is not done right, the cable will corrode and the connection will fail. To make sure this connection is trouble-free, we provide a three-foot connection cable rated for burial underground and specialized waterproof wire nuts. Our wire nuts are filled with a waterproof sealant. Just insert the wires and twist them together. Then bury the cable. The connection will be protected from the elements.

### **Security Bracket and Cable**

Using the security bracket and cable supplied with the loudspeaker provides a simple but effective method to protect the loudspeaker from theft or unapproved movement. You can easily upgrade our standard security mounting method to provided even greater security, if you require it.

## INSTALLATION CONSIDERATIONS

### Tools and Materials Required

- A wire stripper
- 1/2" PVC conduit (optional)
- PVC conduit glue and cleaner (optional)
- PVC cutting tool
- Trench digger or shovel
- Tube of silicon sealant (optional)
- Cable (length and type determined by installation site – see “Choosing the Speaker Cable”)

### Selecting the number and location for your speakers

The RS6 loudspeaker can be installed directly on the ground, in a flowerbed, on a wood deck or on a concrete/stone patio. There are two considerations for placing the loudspeaker, ease of running the cable to the loudspeaker and coverage of the loudspeaker. The RS6 loudspeaker will cover an area of a circle with a 20-foot diameter, in front of the speakers.

If you are using stereo outputs from the amplifier, alternate the speakers to provide the best imaging. You should place speakers less than 10 feet from the sides of the listening area and 15 feet from each other. The row spacing should not be greater than 25 feet. These loudspeaker spacing rules are the recommended maximums; placing speakers at a greater distance apart will negatively affect sound coverage and reduce their stereo effect. Placing speakers closer together will improve sound coverage and produce more stereo coverage.

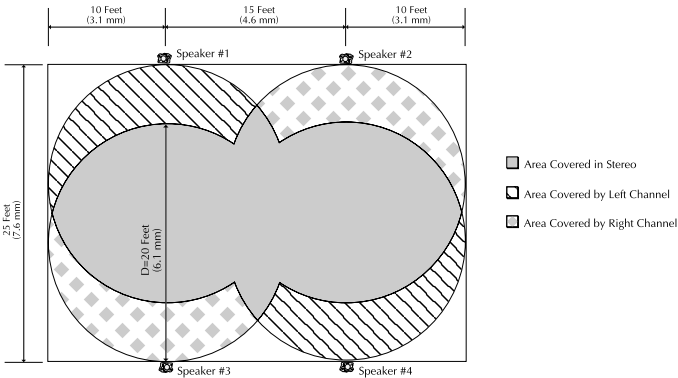
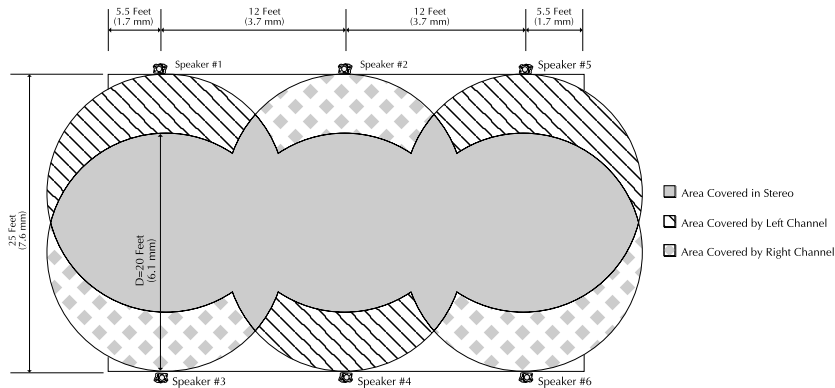


Figure 1 Stereo Coverage 4 speakers

**Figure 1** shows how this would work for a square area of 35 feet by 25 feet and using stereo signals. Using our spacing rules as shown in Table 1, leads to the need for four loudspeakers. The loudspeaker coverage pattern is shown in the diagram.



**Figure 2** Stereo Coverage 6 speakers

**Figure 2** shows the same area as **Figure 1**, however the number of speakers has increased by 2. You can see a greater area of stereo coverage and this would also have a more even sound level across the listening area. This illustrates the fact that not using the maximum spacing allowed leads to improved sound quality.

Achieving high quality stereo coverage in a large area is costly. You need to use more speakers and more amplifier power or separate amplifiers. If a large area needs to be covered, consider using a summed stereo or mono signal for each speaker. If summing the stereo inputs into the amplifier or setting the amplifier to play in mono is acceptable, the loudspeakers can be spaced 10 feet from the sides of the listening area and 20 feet from each other. The row spacing between speakers should be less than 35 feet. This will increase the area your loudspeakers will cover.

Sources	Spacing from Sides	Spacing Between Speakers within a row	Spacing Between Rows
Stereo	10 ft 3.1m	15 ft 4.6m	25 ft 7.6m
Mono	10 ft 3.1m	20 ft 6.1m	35 ft 10.7m

Note: These are maximum recommended distances, sound quality is improved if you use smaller spacings.

**Table 1** Spacing Rules

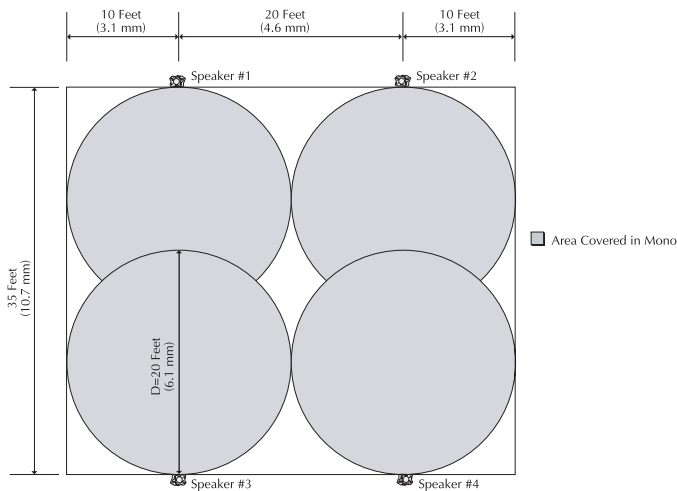


Figure 3 Mono Coverage 4 speakers

Figure 3 shows the difference in coverage area using the spacing rules for mono signals. Using the same four speakers as we did in Figure 1, we can increase our coverage area from 875 square feet (81.3 sq. meters) to 1400 square feet (130.1 sq. meters), simply by using a mono source.

The trade off in sound quality between mono sources and stereo sources is sonic imaging. If you are concerned with keeping the instruments and vocals sonically separated, then stereo setup must be used.

When choosing the location for the loudspeaker, take into consideration the slope of the land in the area the speakers are going to be placed. The flatter and more level the area, the better. The woofer should be straight up and down or tilted forward a bit to assist in drawing water away from it. Never chose a place where an automatic sprinkler will be aimed on or near the loudspeaker. While the loudspeaker is weatherproof, continuous streaming water will shorten the product's life.

**Choosing the Speaker Cable**

In order to choose the proper speaker cable, please follow these steps:

- Unless you are using a Niles' WVC100 or WMVC100 series weatherproof impedance matching volume controls or equivalent, only two (2) RS6 loudspeakers can be safely attached to a typical amplifier channel, if that amplifier is rated to drive 4 ohms. You can do this by running wires from each loudspeaker to the amplifier or you can connect one loudspeaker to another. Make sure this is taken into account when calculating cable length and number of amplifier channels needed. If you are unsure about these calculations, consult an audio/video installer.



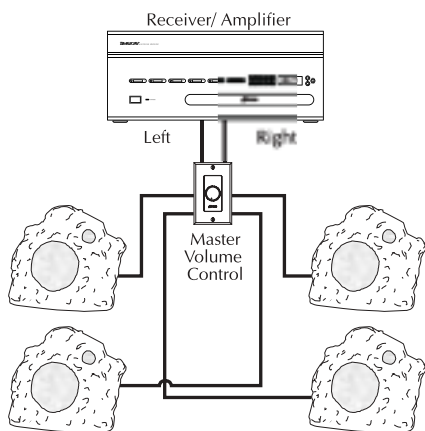
- You will need 2-conductor speaker cable that clearly identifies each conductor in the cable. If burying your cable in the ground is required, use cable rated for direct burial or run cable through PVC pipe. Always use moisture resistant cable.
- After calculating the length of cable needed for each speaker, use the furthest length cable to determine the gauge (thickness) of speaker wire to use:

<u>Wire Gauge</u>	<u>Maximum Distance</u>
16 . . . . .	.60 ft (18 m)
14 . . . . .	.100 ft (30 m)
12 . . . . .	.160 ft (50 m)

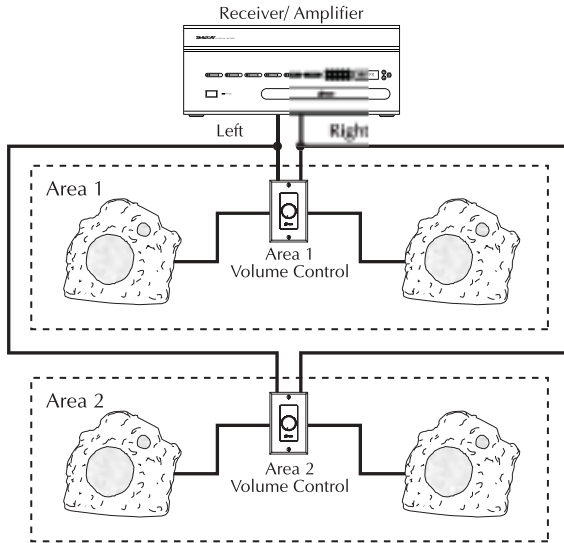
- When running wires inside walls or outdoors, you should install your wires while conforming to your local building requirements and codes. If you are unsure of these codes, consult a professional audio/video installer, building contractor or local building and inspection agency that has jurisdiction.

**Incorporating a Volume Control**

It is possible to control the volume of the sound at the speaker location. Volume controls are connected in line with the speaker, an example of wiring an area with 4 speakers and a master volume control is shown in **Figure 4**. It is usually desirable to control the volume of the speakers in different areas or zones of the outdoor system. A suggested way to accomplish this is shown in **Figure 5**. Niles makes a wide range of outdoor volume controls. We recommend our standard weatherproof volume control, WVC100 series or our weatherproof muting volume control, WMVC series. In addition to controlling the volume of the loudspeakers, these controls can allow the addition of added speakers without adding more amplifier channels.



**Figure 4** One Zone Volume Control Wiring



**Figure 5** Two Zone Volume Control Wiring

Volume controls provide flexibility and customization to make the system reliable and easy to use. Consult your local Niles' dealer for more information about using volume controls.

### Recommended Amplifier Power

We recommend an amplifier with a power rating of ten to one hundred fifty watts per channel for optimum performance. Outdoor speakers typically require more power than indoor speakers. The outdoor environment is usually noisier and has less reflective surfaces to make the system sound louder. Therefore, the use of a higher power amplifier is recommended.

Ironically, most speakers are not damaged by large amplifiers but by small amplifiers. When playing the loudspeaker at higher volumes, a small amplifier will run out of power very quickly. When an amplifier runs out of power it creates damaging "clipping" distortion. A large amplifier will play at the same volume without causing this distortion.

If the plan requires connecting two RS6 speakers on one amplifier channel, an amplifier rated to drive a 4-ohm load of thirty watts to three hundred watts, is recommended. If you use two RS6's on one channel and the amplifier is not rated for driving a 4-ohm load, the amplifier will run out of power more easily and could damage the speakers.

See the section "Operation" for more information about clipping distortion.

## INSTALLATION

### Run the speaker cable

Determine the location of the amplifier that will power the loudspeakers. The amplifier should be located in an area that protects it from the weather. Refer to the amplifier installation instructions to ensure that the amplifier is not located in an area that does not meet its recommended operating environment.

Once the location of the amplifier is determined, layout and place the loudspeakers in the area where music is desired. Use the procedures and recommendations detailed in the section "Selecting the number and location for your speakers" of this manual, to choose the best locations for the speakers.

Determine a path for the speaker cable. You may need to run wires in walls, under sidewalks or patios and around obstacles in your yard. Install the wires while conforming to your local building requirements and codes. If you are unsure of these codes, consult a professional audio/video installer, building contractor or local building and inspection agency that has jurisdiction. Use care when digging trenches in the yard; ensure that there are no buried cables or gas lines by verifying the location of these items with the local authorities in your area, prior to digging the trenches.

After selecting this path, estimate the amount of cable needed and use the section entitled "Choosing the Speaker Cable" to choose and cut the cable required.

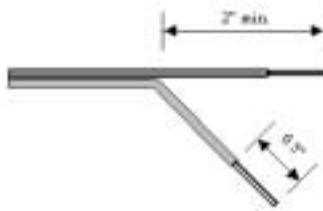
If the cable will be run underground, dig a trench along the path needed for the speaker cable. If you are using PVC pipe to run your cable in, connect and glue the PVC piping sections and connections together so they lie in this trench easily. Now run the cable from the amplifier to each speaker location through the pipe. If you are using direct burial cable, run the cable from the amplifier to each speaker location and lay the cable in the trench.

Do not cover the cable in the trenches until system operation and loudspeaker coverage is verified.

### Connecting the loudspeaker

1. Strip two to three inches of the speaker cables' outer jacket away from the insulated conductors. Ensure that at least two inches of the separate conductors are free.
2. Strip one half inch of insulation from the end of each conductor as show in **Figure 6**.
3. Perform steps 1 and 2 on the **RS6**'s connection cable.

4. Connect one stripped end of the speaker cable coming from the amplifier to the **RS6** connection cable's red wire. To connect the two wires, twist the stripped ends of the wire together and screw down the wire nut on the twisted wires. The material inside the wire nut will protect the stripped ends of the wire. However, if added protection is desired, place a large amount of silicon sealant so the bottom of the wire nut is encased and sealed. Pay attention to the markings on the speaker cable. Each loudspeaker you connect must be connected to the amplifier's speaker wire in the same way.
5. Repeat step 4 with the **RS6** connection cable's black wire and the other stripped amplifier speaker cable's conductor.
6. Connect the opposite end of the speaker cable to the amplifier or receiver. Start by performing step 1 and 2 on the speaker cable near the amplifier. Paying attention to the markings on the speaker cable conductor, attach the same conductor you attached to the red loudspeaker wire to the positive (red) or (+) amplifier output terminal. Attach the other conductor to the amplifier's negative (black) or (-) amplifier output terminal.



**Figure 6** Speaker wire preparation

### Speaker Phase

Speaker wire has two conductors. One conductor is attached to the negative (black) or (-) terminals and one conductor is attached to the positive (red) or (+) terminals of both the loudspeaker and the amplifier. Usually, the wire is marked for your convenience. There are different ways to mark the conductor; a stripe on one wire, a ribbed area on one conductor that you can feel, different color metal conductor wire inside the insulation, the insulation covering the conductor might be different colors, or there might be a fabric string wound onto one of the conductors. Of course some cables make it difficult to determine which conductor is which. Be careful to avoid mistakes. If you do, one loudspeaker will be playing out of "phase" with the other loudspeaker. An out of phase pair of speakers work against each other and the sound of the two speakers playing together will be lacking in bass response and have a "phasey" sound quality. If you suspect the sound is not right, check to make sure that the conductors on each loudspeaker are attached the same on the loudspeaker and the amplifier. If you cannot see any markings or determine if they are all attached the same, try this simple test:

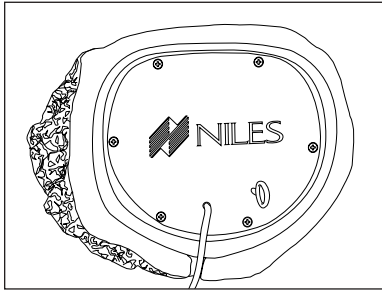
1. Point the speakers at each other, rather than at the area you want to cover.
2. Play some music with the amplifier or receiver set to Mono.
3. Stand so you are the same distance from each speaker and listen to the richness of the bass and the loudness of the sound.
4. Turn off the amplifier and reverse the connections on one speaker only.
5. Repeat the listening test with the same setting of the volume controls. If the current sound has a richer bass and is slightly louder than the previous sound, the speakers are working together and are "in-phase". Leave the speakers connected to the amplifier in this configuration. If the current sound is not richer in bass or louder than the previous sound, turn off the amplifier and reverse the connections of the wire you moved in step 4.

#### **Verify System Operation and Loudspeaker Coverage**

1. Turn the system "On" and play music to the speakers. Set the Volume controls to a level that allows the speakers to be easily heard over the "noise" in the area.
2. Verify that music is playing through each speaker. If not, trouble shoot the wiring and make sure each speaker is electrically connected to the amplifier.
3. If you attached your loudspeakers in a stereo mode, verify that they are connected to the proper channel of the amplifier. To do this, change the balance of your speakers on your amplifier or receiver so that one channel is at playing loudly and the other is not. Verify that the speakers are attached to the proper channel per the layout of the loudspeakers on the plans. If they are not, correct the wiring on the loudspeaker that is not connected properly. Reset the balance on the amplifier or receiver so both channels have a similar volume level.
4. If you used a volume control between the amplifier and the speakers, verify that it is controlling the volume of the loudspeakers in its zone. Repeat this for every volume control in the system. If it is not, correct the wiring.
5. Point the loudspeakers per the layout and verify that the sound is even and consistent throughout the area.

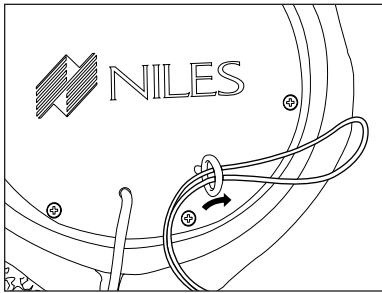
## Installing the Security Bracket and Cable

1. With the loudspeaker in the proper location per the layout, turn the loudspeaker over so the bottom of the loudspeaker is facing you, as shown in **Figure 7**.



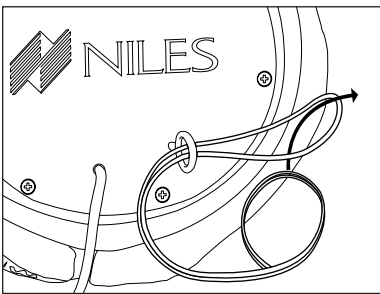
**Figure 7** Bottom of Loudspeaker

2. Take the nylon security cable, supplied with the loudspeaker and fold it in half. Using the middle of the cable, feed it through the Security Attachment Eyelet as shown in **Figure 8**.

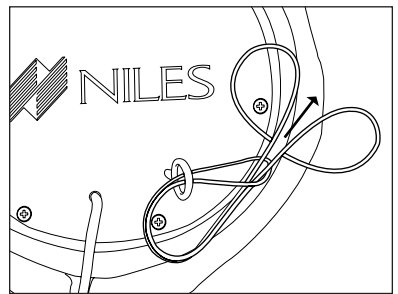


**Figure 8** Security Cable in Eyelet

3. Feed the opposite end of the nylon security cable through the exposed portion of the cable that was just fed through the security eyelet, as shown in **Figure 9** and **10**.

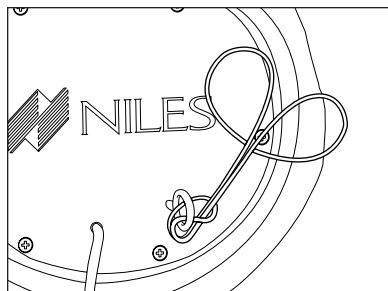


**Figure 9** Security Cable Looping Through



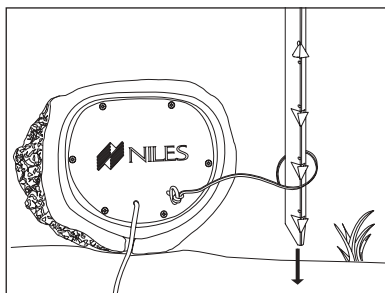
**Figure 10** Security Cable after Looping

4. Pull the ends of the security cable with the loops as tight as you can until the knot around the security eyelet is tightened as shown in **Figure 11**.



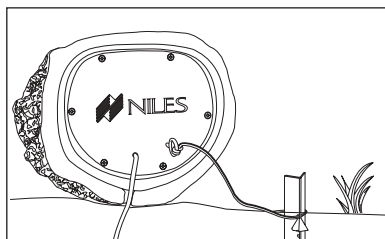
**Figure 11** Security Cable  
Connected and Tightened

5. Feed the Security Stake through the loops at the end of the security cable and insure that they are inserted into the cable holder provided at the top of the stake, as shown in **Figure 12**.



**Figure 12** Security Stake  
Attachment to Cable

6. Pick a spot in the ground which the loudspeaker will cover and drive the security stake all the way into the ground until the cable holder is completely under the surface of the ground, as shown in **Figure 13**.



**Figure 13** Security Stake  
Driven into Ground

7. Pull on the security cable and verify that the stake is securely held in the ground.

### Upgraded Security Attachment Method (Optional)

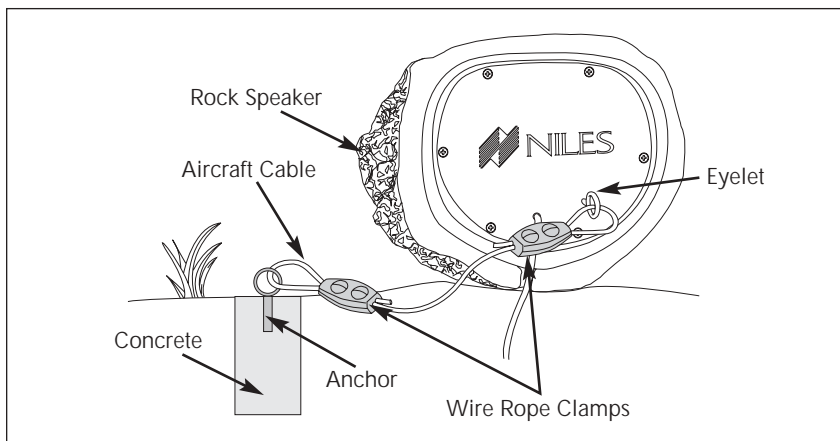
To perform this attachment method you will need the following items:

1. (1) Stainless Steel Eyebolt
2. (1) Concrete Anchor sized to the Stainless Steel Eyebolt
3. (1) Bag of Quikcrete – fast drying cement mix or equivalent
4. A post hole digger or shovel
5. (1) Stainless Steel Aircraft Cable 1/8" diameter or larger
6. (2) Stainless steel wire rope clamps sized to the aircraft cable chosen

#### To install an upgraded security system:

1. Prepare a hole that is at least one-foot deep, at a minimum (three-feet if the speaker is being installed in an area that has a frost line). The hole should be at least six inches in diameter. This hole should be under the desired location of the loudspeaker.
2. Once the hole is prepared, mix the concrete per its' instructions. Fill the hole with concrete. Place the concrete anchor in the center of the concrete so the top of the anchor is flush with the top of the concrete and the anchor is not filled with concrete.
3. Wait until the concrete is dried per the instructions on the concrete mix used.
4. Screw the stainless steel eyebolt into the concrete anchor
5. Feed one end of the stainless steel aircraft cable through the eyebolt in the concrete
6. Loop the end of the aircraft cable around the eyebolt and back to the aircraft cable. Secure this end of the cable to the main aircraft cable with the wire rope clamp.
7. Turn the loudspeaker over and feed the other end of the aircraft cable through the eyelet in the bottom of the loudspeaker.
8. Loop this end of the aircraft cable around the eyelet and back to the aircraft cable. Secure this end of the cable to the main aircraft cable with the wire rope clamp. The upgraded attachment should now look like **Figure 14**.





**Figure 14** Upgraded Security Attachment

### Final Adjustments

Now that the loudspeaker's phase, operation and security is assured, there are some final steps to ensure that the loudspeakers installation is complete and that they are used at their full potential.

1. Cover any trenches or wires that are still open or exposed.
2. Point the loudspeakers per the layout and verify that the sound is even and consistent throughout the area that sound is desired, as you did in step 5 of verifying system operation.
3. Verify that the front of the loudspeaker is as close to perpendicular to the ground as possible. This will aid the drainage of water away from the woofer and improve sound quality.
4. Check that the entire installation is safe and secure.

## OPERATION

### Listening at Higher Volumes

Outdoors there are no walls to reflect and contain the sound and typically the ambient noise level is louder. This causes the system to require more power to achieve a reasonable listening level than it does when you are listening indoors. In addition, you are frequently further away from the loudspeaker. It is possible to turn the volume so high that the amplifier runs out of power. This creates "clipping" distortion.

Clipping distortion makes treble sound very harsh and unmusical. When you hear harsh sounding treble from any good speaker indoors or outdoors, turn the volume down immediately! Those harsh sounds are masking some much more powerful ultra-high-frequency sound spikes that will quickly damage any fine loudspeaker.

### Cleaning

The rock loudspeaker should not require cleaning. The formation of dirt and molds on the cabinet will add to the natural look of the loudspeaker. However, if you desire to clean the loudspeaker you can clean the **RS6** with a dampened soft cloth or a paper towel. Hosing the loudspeaker off with a garden hose or high pressure cleaner is not recommended, the drivers, especially the tweeter, can be damaged by a high-pressure stream of water. The use of chemical cleaners should also be avoided.

## SPECIFICATIONS

### Recommended Amplifier Power

10 to 150 Watts

### Nominal Impedance

8 Ohms

### Frequency Response

60 Hz to 21 kHz

### Sensitivity

89 decibels for 2.83 Volts RMS of Pink Noise, measured at 1 Meter on Axis

### Wiring Requirements

2-conductor direct burial cable at the following sizes depending on longest length of cable required:

<u>Wire Gauge</u>	<u>Maximum Distance</u>
16 . . . . .	.60 ft (18 m)
14 . . . . .	.100 ft (30 m)
12 . . . . .	.160 ft (50 m)

### Temperature Extremes

-50° to 185° Fahrenheit

-45° to 85° Celsius

### Dimensions

14" Length x 11" Deep x 12" High

356mm Length x 279mm Deep x 305mm High

### Weight (Loudspeaker Only)

17.5 lbs.

7.9 kgs.

NOTES

---

---

---

---

---

---

---

---

---

---

---

---

---

---

---

---

---

---

---

---

---

---

---

---

---

---

---

---

PLEASE FILL OUT THE  
WARRANTY REGISTRATION  
CARD ON THE REVERSE SIDE,  
DETACH, AND MAIL TO:

**Niles Audio Corporation**  
**Warranty Registration Dept.**  
**P.O. Box 160818**  
**Miami, Florida 33116-0818**

DETACH HERE



# WARRANTY REGISTRATION CARD

Model Purchased \_\_\_\_\_

Serial Number (if applicable) \_\_\_\_\_

Date Purchased (month/day/year) \_\_\_\_\_

Dealer Name and Location \_\_\_\_\_

Dr.     Miss     Mr.     Mrs.     Ms.

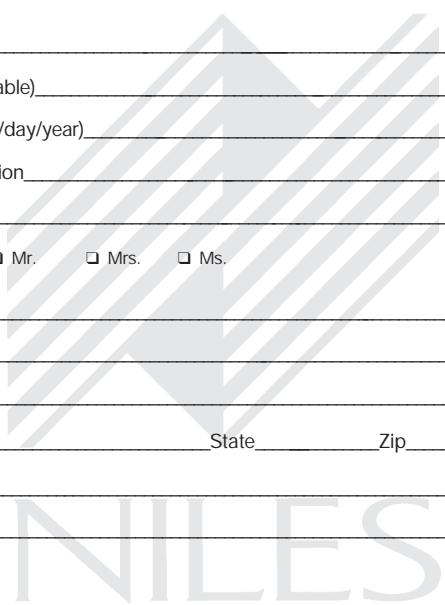
Name \_\_\_\_\_

Address \_\_\_\_\_

City \_\_\_\_\_ State \_\_\_\_\_ Zip \_\_\_\_\_

Telephone ( \_\_\_\_\_ ) \_\_\_\_\_

e-mail Address \_\_\_\_\_



Please take a moment to fill out our warranty registration card. The information helps us to get to know you better and develop the products you want

**Age:**

- Under 25
- 25-34
- 35-44
- 45-54
- 55 & over

**Income:**

- Under \$24,999
- \$25,000-\$34,999
- \$35,000-\$44,999
- \$45,000-\$59,999
- \$60,000-\$74,999
- \$75,000-\$99,999
- Over \$99,999

**Occupation:**

- Arts/Entertainment
- Business Owner
- Engineer
- Finance/Accounting
- General Office
- Management
- Professional
- Sales/Marketing
- Student
- Tradesperson

**Musical tastes:**

(Please check all that apply)

- Alternative
- Classical
- Country
- Jazz
- New Age
- Popular
- R&B
- Rock
- Other \_\_\_\_\_

**How did you hear about Niles?**

- Architect/Developer
- Custom Installer
- Direct Mail
- Friend/Family
- In-Store Display
- Interior Designer
- Magazine Ad
- Mail-Order Catalog
- Newspaper Ad
- Product Brochure
- Product Review
- Retail Salesperson

**What magazines do you read?**

1. \_\_\_\_\_
2. \_\_\_\_\_
3. \_\_\_\_\_

**Who will install the product?**

- Custom Installer
- Electrician
- Friend
- Myself

**Which factor(s) influenced the purchase of your Niles product?**

(Please check all that apply)

- Ease of Use
- Price/Value
- Product Features
- Quality/Durability
- Reputation
- Style/Appearance
- Warranty

**Do you . . . ?**

Own a House. If yes, how many square feet?

\_\_\_\_\_

Own a Town House/Condominium/Co-op

Rent an Apartment

Rent a House

**Are you interested in receiving literature on other Niles products?**

Yes     No

**What products/capabilities would you like to see developed in the future?**

\_\_\_\_\_  
 \_\_\_\_\_  
 \_\_\_\_\_  
 \_\_\_\_\_  
 \_\_\_\_\_  
 \_\_\_\_\_

## 5 YEAR LIMITED WARRANTY

Niles Audio Corporation ("NILES") warrants its rock loudspeaker products to the original purchaser to be free of manufacturing defects in material and workmanship for a period of five years from date of purchase.

This Warranty is subject to the following additional conditions and limitations. The Warranty is void and inapplicable if NILES deems that the product has been used or handled other than in accordance with the instructions provided by the manufacturer, including but not limited to damage caused by accident, mishandling, improper installation, abuse, negligence, or normal wear and tear, or any defect caused by repair to the product by anyone other than NILES or an authorized NILES dealer.

To obtain warranty service, take the unit to the nearest authorized NILES dealer, who will test the product and if necessary, forward it to NILES for service. If there are no authorized NILES dealers in your area, you must write to NILES and include your name, model and serial number of your unit, along with a brief description of the problem. A factory Return Authorization Number will be sent to you. **DO NOT RETURN ANY UNIT WITHOUT FIRST RECEIVING WRITTEN AUTHORIZATION AND SHIPPING INSTRUCTIONS FROM NILES.**

If the above conditions are met, the purchaser's sole remedy shall be to return the product to NILES, in which case NILES will repair or replace, at its sole option, the defective product without charge for parts or labor. NILES will return a unit repaired or replaced under warranty by shipping same by its usual shipping method from the factory (only) at its expense within the United States of America. **THERE ARE NO OTHER WARRANTIES, INCLUDING WITHOUT LIMITATION, EITHER EXPRESS OR IMPLIED WARRANTIES OF MERCHANTABILITY OR FITNESS FOR A PARTICULAR PURPOSE, WITH RESPECT TO THE PRODUCT.**

**REPAIR OR REPLACEMENT AS PROVIDED UNDER THIS WARRANTY IS THE EXCLUSIVE REMEDY OF THE CONSUMER/PURCHASER. NILES SHALL NOT BE RESPONSIBLE FOR ANY INCIDENTAL OR CONSEQUENTIAL DAMAGES EXCEPT TO THE EXTENT PROVIDED (OR PROHIBITED) BY APPLICABLE LAW.**

Some states do not allow the exclusion or limitation of incidental or consequential damages, so the above limitation may not apply to you. This warranty gives you specific legal rights, and you may also have other rights which vary from state to state.

For the name of your nearest authorized NILES dealer contact:

**NILES AUDIO CORPORATION**

P.O. BOX 160818, Miami, Florida 33116-0818.

1-800-BUY-HIFI (800-289-4434)

Please fill in your product information and retain for your records.

Model \_\_\_\_\_

Serial No. \_\_\_\_\_

Date Purchased \_\_\_\_\_



NILES®

Niles Audio  
Corporation  
12331 S.W. 130 Street  
Miami, Florida 33186  
Tel: (305) 238-4373  
Fax: (305) 238-0185

Printed in China

© 2003 Niles Audio Corporation. DS00332ACN