

Vena

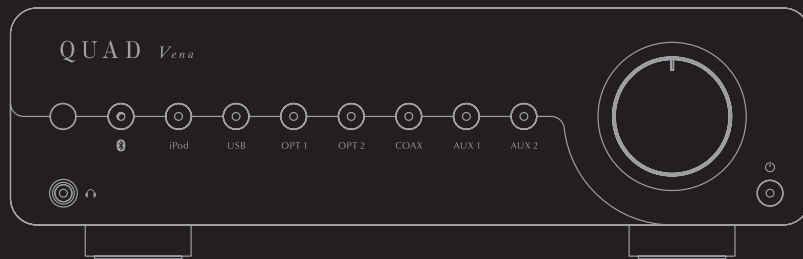

Integrated Amplifier



**AVAILABLE AT
DIGITAL CINEMA**

Owner's Manual

QUAD *the closest approach to the original sound*

IMPORTANT SAFETY INFORMATION

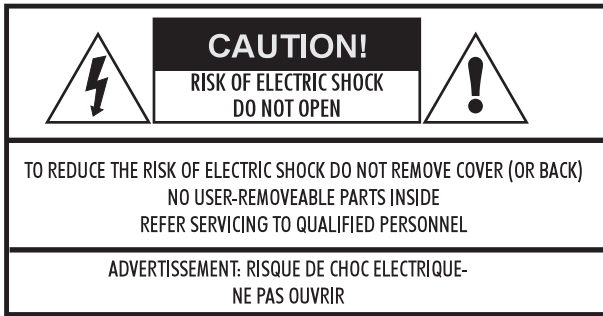

This symbol indicates that there are important operating and maintenance instructions in the literature accompanying this unit.



This symbol indicates that dangerous voltage constituting a risk of electric shock is present within this unit.

Read these instructions.

Keep these instructions.

Heed all warnings.

Follow all instructions.

Do not use this apparatus near water.

Clean only with dry cloth.

Do not block any ventilation openings.

Install in accordance with the manufacturer's instructions.

Do not install near any heat sources such as radiators, heat registers, stoves, or other apparatus (including amplifiers) that produce heat.

Do not defeat the safety purpose of the polarised or grounding type plug.

A polarised plug has two blades with one wider than the other. A grounding type plug has two blades and a third grounding prong. The wider blade or the third prong is provided for your safety. If the provided plug does not fit into your outlet, consult an electrician for replacement of the obsolete outlet.

Protect the power cord from being walked on or pinched particularly at the plugs, convenience receptacles, and the point where they exit from the apparatus.



Use only with the cart, stand, tripod, bracket, or table specified by the manufacturer, or sold with the apparatus. When a cart or rack is used, use caution when moving the cart/apparatus combination to avoid injury from tip-over.

Unplug the apparatus during lightning storms or when unused for long periods of time.

Refer all servicing to qualified service personnel. Servicing is required when the apparatus has been damaged in any way, such as power supply cord or plug is damaged, liquid has been spilled or objects have fallen into the apparatus, the apparatus has been exposed to rain or moisture, does not operate normally, or has been dropped.

CAUTION: These servicing instructions are for use by qualified service personnel only. To reduce the risk of electric shock, do not perform any servicing other than that contained in the operating instructions unless you are qualified to do so.

Do not install this equipment in confined or built-in space such as a bookcase or similar unit, and keep well ventilated

in open space. The ventilation should not be impeded by covering the ventilation openings with items such as newspaper, table-cloths, curtains etc.

WARNING: Only use attachments/accessories specified or provided by the manufacturer (such as the exclusive supply adapter, battery etc.).

WARNING: To reduce the risk of fire or electric shock, do not expose this apparatus to rain or moisture. The apparatus shall not be exposed to dripping or splashing and ensure that objects filled with liquids, such as vases, shall not be placed on apparatus. No naked flame sources, such as lighted candles, should be placed on the apparatus.

WARNING: Terminals marked with symbol of "⚡" may hold voltage of sufficient magnitude to constitute a risk of electric shock. The external wiring connected to the terminals requires installation by qualified personnel or the use of ready-made leads or cords.

WARNING: Danger of explosion if battery is incorrectly replaced. Replace only with the same or equivalent type.

WARNING: The battery (battery or batteries or battery pack) shall not be exposed to excessive heat such as sunshine, fire or the like.

WARNING: Excessive sound pressure from earphones and headphones can cause hearing loss.

WARNING: Listening to music at high volume levels and for extended duration can damage one's hearing. In order to reduce the risk of damage to hearing, one should lower the volume to a safe, comfortable level, and reduce the amount of time listening at high levels. Headsets should comply with EN 50332-2 requirements (for GS certification).

WARNING: The mains plug is used as disconnection device; the disconnection device shall remain readily operable. The mains switch and circuit breakers are not provided with the apparatus; the installation shall be carried out in accordance with all applicable installation rules.

 This equipment is a Class II or double insulated electrical appliance. It has been designed in such a way that it does not require a safety connection to electrical earth.

IMPORTANT NOTICE TO UK USERS

The appliance cord is terminated with a UK approved mains plug fitted with a 5A fuse. If the fuse needs to be replaced, an ASTA or BSI approved BS1362 fuse rated at 5A must be used. If you need to change the mains plug, remove the fuse and dispose of this plug safely immediately after cutting it from the cord.

Connecting a Mains Plug

The wires in the mains lead are coloured in accordance with the code: Blue: NEUTRAL; Brown: LIVE; Green and Yellow: Earth. As these colours may not correspond to the coloured markings identifying the terminals in your plug, proceed as follows:

The BLUE wire must be connected to the terminal marked with the letter N or coloured BLUE or BLACK. The BROWN wire must be connected to the terminal marked with the letter L or coloured BROWN or RED.

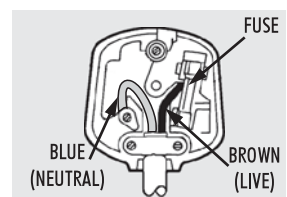

CONTENTS

IMPORTANT SAFETY INFORMATION	Inside Front Cover
INTRODUCTION	1
UNPACKING THE EQUIPMENT	1
PLACEMENT	1
CONTROLS AND CONNECTIONS	2
INSTALLATION	3
REMOTE HANDSET	7
OPERATION	8
SPECIFICATIONS	10
CARE AND CLEANING	11



The Bluetooth[®] word mark and logos are registered trademarks, owned by Bluetooth SIG, Inc. and any use of such marks by IAG Group Ltd is under license. Other trademarks and trade names are those of their respective owners.



aptX[®] software is copyright CSR plc. or its group companies. All rights reserved.

The aptX[®] mark and the aptX logo are trademarks of CSR plc. or one of its group companies and may be registered in one or more jurisdictions.

INTRODUCTION

Thank you for your investment in QUAD Vena. We are sure that Vena will continue to delight you for years to come.

QUAD Vena is designed to be the perfect match to a wide variety of sources and provides the necessary amplification to realise the highest quality of your stored music replayed through your loudspeakers and headphones.

You can link Vena to both analogue and digital sources thanks to its diversity of inputs. You can also stream music to Vena from any Bluetooth[®] device such as portable music players and smartphones. QUAD Vena is designed with the innovative aptX. codec built in so that you can hear CD quality audio over the Bluetooth wireless connection.

Please read this manual carefully to discover all the ways you can connect your equipment to QUAD Vena and how to get the best performance from your stored music.

UNPACKING THE EQUIPMENT

The QUAD Vena carton contains:

- The QUAD Vena integrated amplifier
- One IEC mains cable with a plug suitable for your area
- One remote handset
- One battery for remote handset
- One antenna (metal enclosure only)
- This owner's manual
- Warranty registration form

Consult the dealer from whom you purchased the equipment if any item is not present. Carefully unpack the unit and accessories, so as not to damage the surface finish. Retain the packing materials for future use. Retain the user manual and information concerning the date and place of purchase of your equipment for future reference. If you transfer any unit to a third party please pass on this instruction manual along with the equipment.

PLACEMENT

Place the unit on a sturdy shelf or table. The unit is designed to run warm during normal operation. Do not place anything on top of the unit. If you are using an equipment rack ensure the unit has sufficient space to allow adequate ventilation and is on its own shelf.

Before you connect the QUAD Vena to the mains, ensure your mains voltage corresponds to the rating on the rear panel of the product. If in doubt, consult your dealer. If you move to an area which has a different mains voltage seek advice from a QUAD appointed dealer or a competent service technician.

CONTROLS AND CONNECTIONS

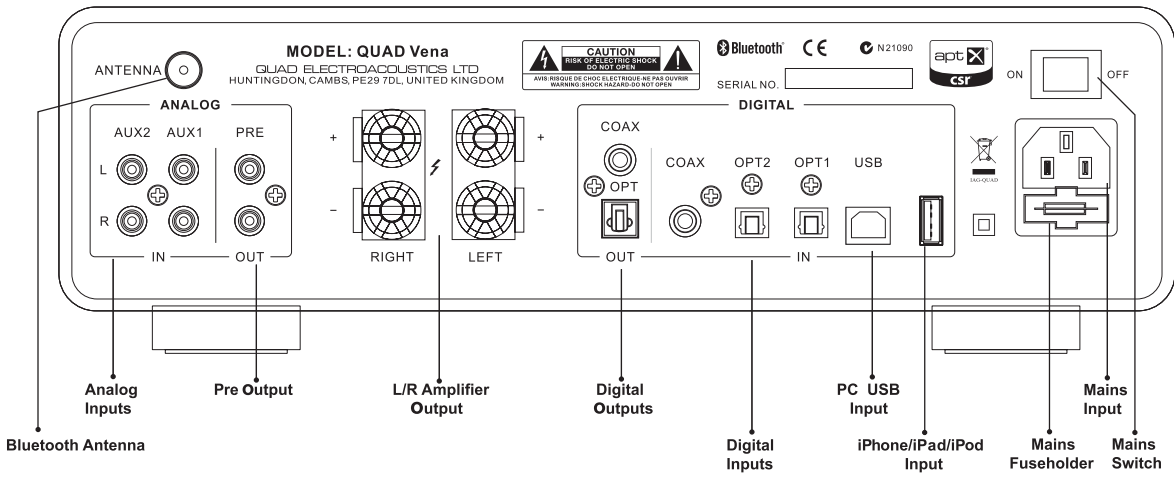
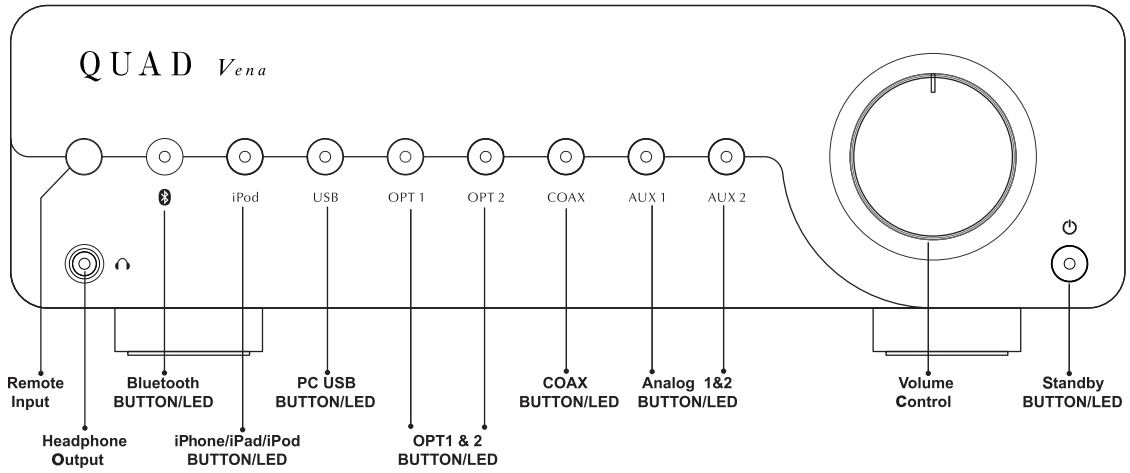

INSTALLATION

Before making any connections to your high fidelity equipment make sure that all units in the system are switched off and unplugged at the mains.

Mains Connections

The Mains On/Off switch is on the rear panel. Before connecting your QUAD equipment to the AC mains supply check and make sure the voltage marked on the back matches your supply voltage.

Digital Signal Output Connections

Coaxial Output

Vena has one coaxial SPDIF output. Connect an RCA digital interconnect between the digital coaxial out of Vena unit and the required input of your equipment.

Optical Outputs

Vena has one optical SPDIF output. Connect an optical (TOSLink) interconnect between the digital optical out of Vena and the required input of your equipment.

Analog Signal Output Connections

Preamplifier Output

Vena has one pair of unbalanced RCA outputs which can make Vena operate as a preamplifier.

Connect an RCA cable between the unbalanced pre output of Vena and the unbalanced input of a power amplifier or associated equipment. Interconnection should be low-noise construction and fully screened to minimize hum and noise transmission.

Loudspeaker Outputs

Vena has two sets of loudspeaker outputs. They are independent for right and left stereo amplifier outputs.

Connect the Positive (+) RED terminals of the amplifier to the Positive (+) RED terminals of the loudspeakers. Connect the Negative (-) BLACK terminals similarly. When connecting loudspeakers tighten the terminals securely by hand. Make sure there are no loose strands of wires which could cause short circuits.

Headphone Output

Vena has a stereo 6.3mm(1/4") jack on the front panel for connecting headphones. Connecting headphones mutes the audio signal to the loudspeakers. Vena's headphone output can be set up to 3.5V, users can select suitable output levels to suit their headphones.

WARNING: Listening to music at high volume levels and for extended durations can damage one's hearing. In order to reduce the risk of damage to hearing, one should lower the volume to a safe, comfortable level, and reduce the amount of time listening at high levels. Headsets should comply with EN 50332-2 requirements (for GS certification).

Output Connections

QUAD Platinum DMP

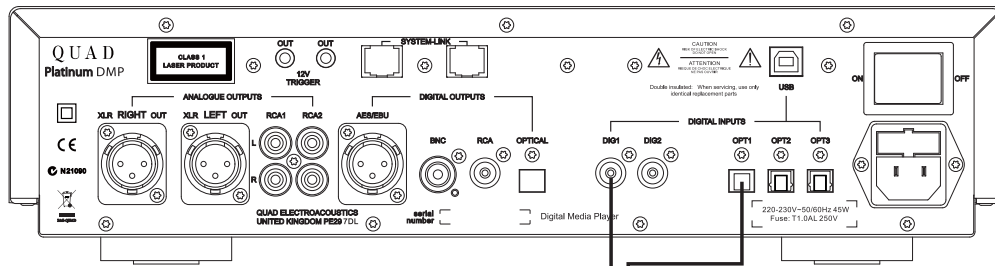

Loudspeaker Right

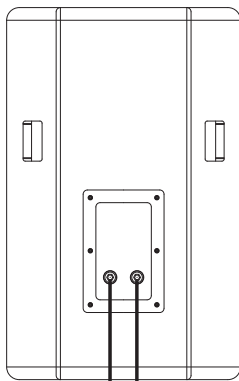

Loudspeaker Left

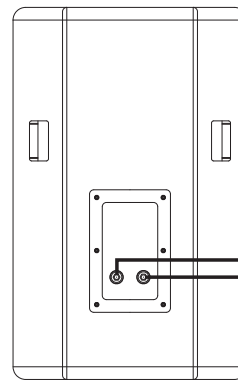

QUAD Vena

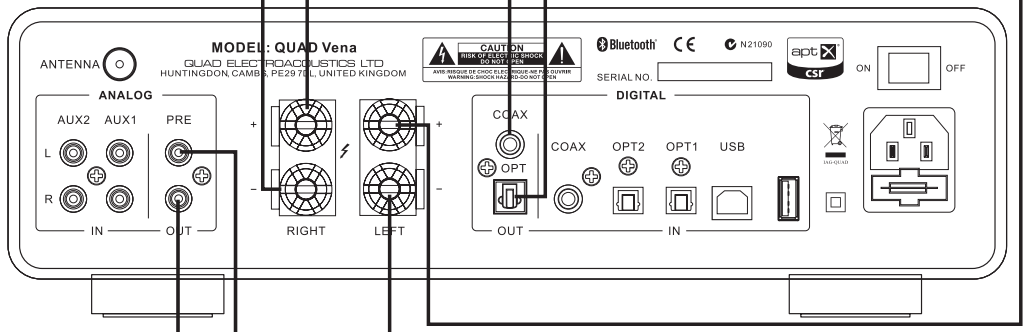

QUAD Platinum Stereo Amplifier

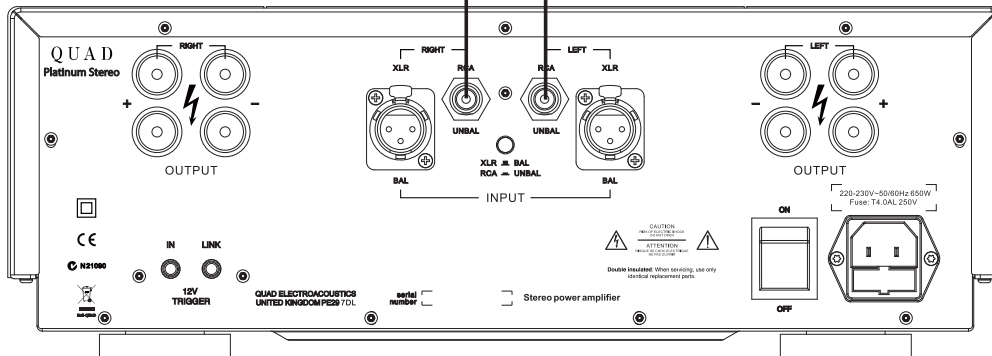

Analog Signal Input Connections

Vena has two sets of unbalanced RCA inputs for connection to units which do not feature balanced outputs. Both sets are identical.

Connect an RCA cable between the unbalanced input of Vena and the unbalanced output of a source unit like a CD player or DAC. Interconnections should be low-noise construction and fully screened to minimize hum and noise transmission.

Digital Signal Input Connections

Vena has a variety of digital inputs, which can be connected to most popular digital sources, like the digital output of a CD or DVD player, DAC, PC, iPhone, iPad and so forth.

Coaxial Inputs

Vena has a coaxial SPDIF input. Connect an RCA digital interconnect between the digital coaxial out of the source unit to the COAX input of Vena.

Optical Inputs

Vena has two optical SPDIF inputs. Connect an optical (TOSlink) interconnect between the digital optical output of the source unit to the OPT1 or OPT2 input on Vena.

Bluetooth Input

Vena has a built-in Bluetooth signal processor module which can play audio files transmitted from the source unit via Bluetooth wireless transmission. Please refer to page 9 to enable this function.

USB Input

Vena has one B-type USB input which lets you connect a Mac or PC to Vena to play audio files stored on a computer. Connect a USB cable from a USB A-type port on the computer to the USB B-type input on Vena.



A-type USB



B-type USB

Apple Docking Input

Vena has one A-type USB input which is suitable for Apple docking to enable you to connect an iPhone, iPad or iPod (refer to page 9) to play their audio files. Connect a specified Apple USB cable from iPhone, iPad or iPod to the A-type USB input on Vena.

Input Connections

QUAD Platinum DMP

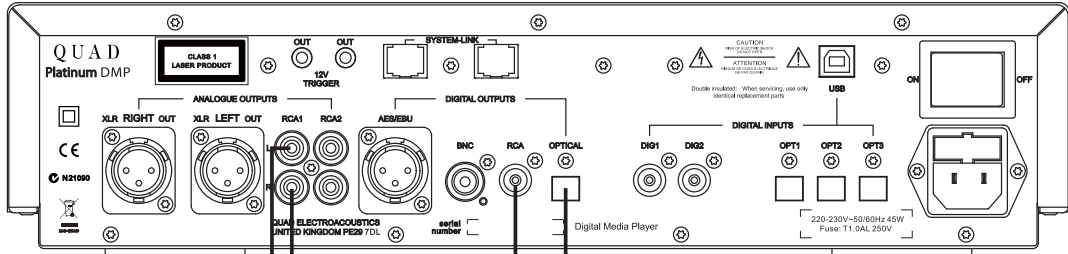

Bluetooth
Antenna

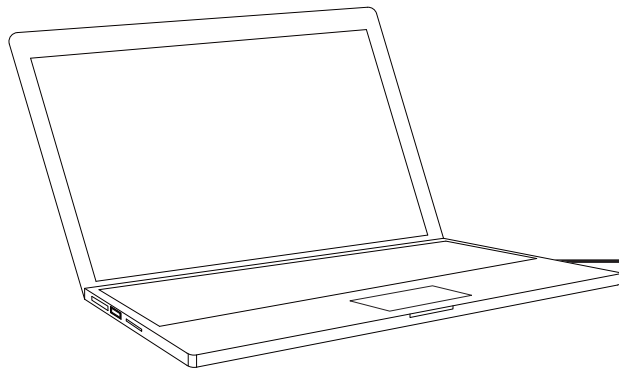
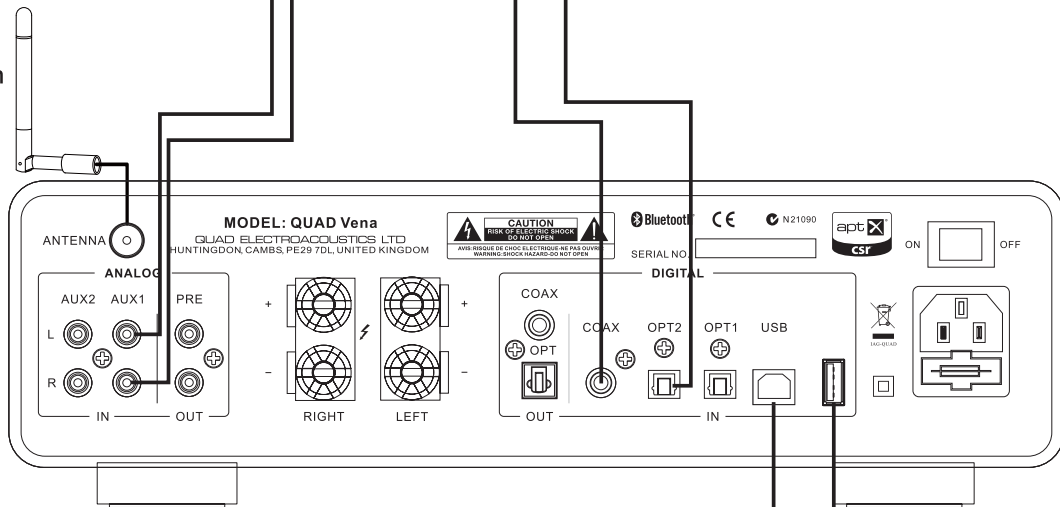

Computer

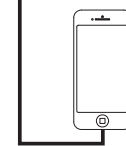

iPhone/iPad/iPod

REMOTE HANDSET

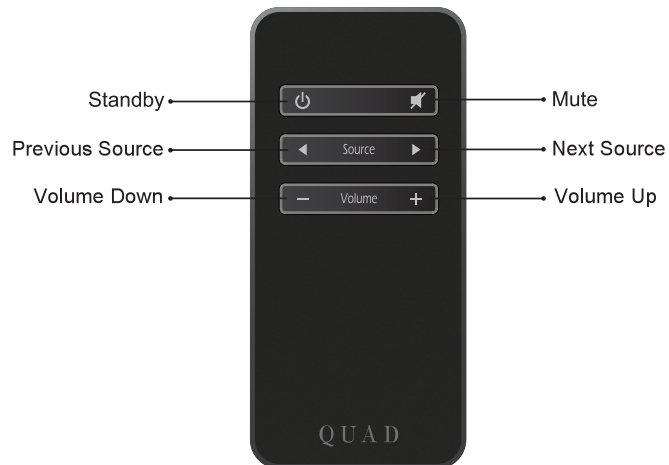

Press to bring product in/out of standby mode



Press to Mute/Unmute the sound. In Mute, the selected source indicator on front panel will flash on and off



Press to select previous source



Press to select next source



Press to increase volume



Press to decrease volume

The selected source indicator will flash when Vena responds to remote commands.

Preparing the Handset

- Unpack the handset
- Invert the handset
- Remove the battery cover
- Insert a new battery
- Close the battery cover

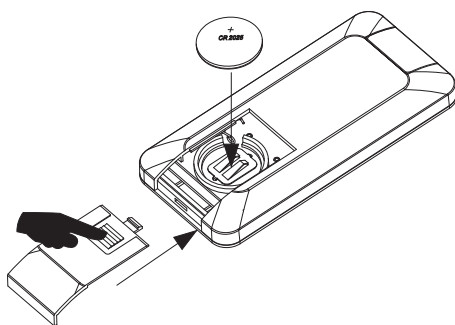



Battery Caution

- There is a risk of fire and burns if the battery is handled improperly.
- Do not disassemble, crush, puncture, short external contacts or dispose in fire or water.
- Do not attempt to open or service the battery. Replace only with a **CR2025** battery.
- Discard used batteries in accordance with recycling regulations in force in your area.

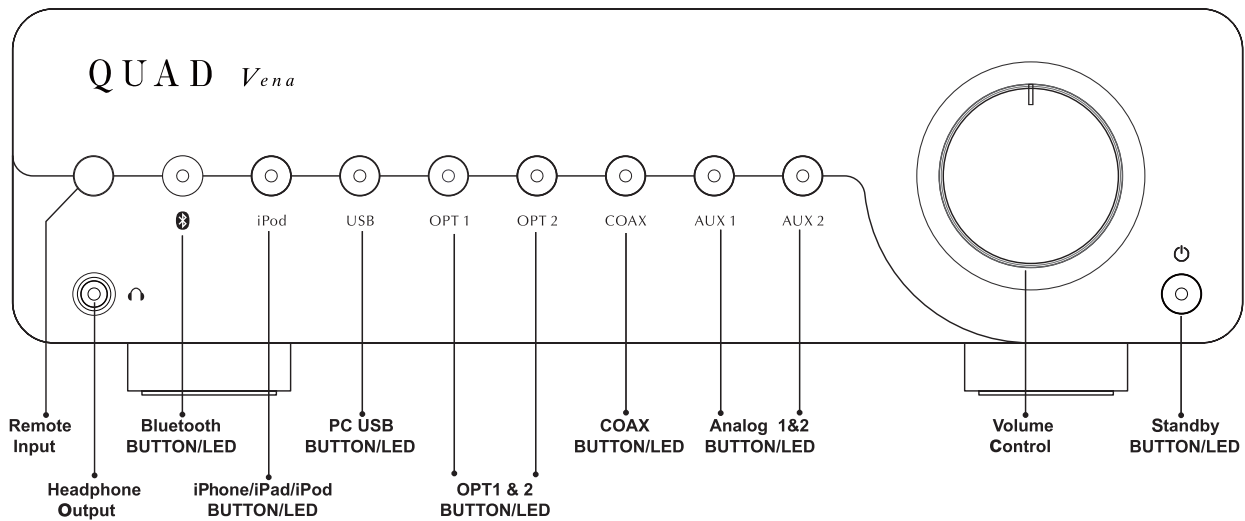
OPERATION



Standby Mode

Vena will be in standby mode when powered on. The  indicator on front panel is lit. Press  button to bring Vena out of standby. Vena will automatically go into standby mode when there is no signal input or operation for 30 minutes. Vena will be switched to the Bluetooth source input when unit is activated for the first time, and switched to the last input source used after that.

Protection Mode

Vena is protected by a thermal switch which interrupts the AC Power supply if the amplifier is grossly overloaded for a period of time. To restore operation, simply press the  button on the front panel. It is thus fully protected against gross overload, short-circuited output etc, but not necessarily against seriously inadequate ventilation.

Mute Mode

Vena will go into Mute mode with no sound output for 3 seconds when the unit is switched on and all indicators will flash 3 times. After 3 seconds the indicators will stop flashing and Vena will exit from Mute mode.

Users can also press  to bring Vena in or out of Mute mode when playing music.

Volume knob

Vena has a volume control knob on the front panel. Users can decrease or increase the music level with this volume knob. Please always turn up the volume gradually.

Playing Music via Analog Inputs

Connect the analog signal of a source unit to Vena's **AUX1** or **AUX2** input. Press **AUX1** or **AUX2** button on the front panel. **AUX1** or **AUX2** indicator will be lit and music will start playing.

Playing Music via Digital Inputs

Connect coaxial SPDIF signal of source units to the digital in **COAX** jack on Vena's rear panel. Press **COAX** button on the front panel, **COAX** indicator will be lit and music will start playing.

Connect optical (TOSLink) signal of source units to Vena's **OPT1** or **OPT2** jack on Vena's rear panel. Press **OPT1** or **OPT2** button on the front panel. **OPT1** or **OPT2** indicator will be lit and music will start playing.

Playing Music via USB input

Connect a Mac or PC via the B-type **USB** interface on Vena's rear panel. Press **USB** button on the front panel. **USB** indicator will be lit, and then click **Play** on your music player software to play audio files stored on your computer.

Playing Music via Apple Docking

Connect an Apple unit as shown in the following list via a specified Apple USB cable to the iPhone/iPad/iPod input on Vena's rear panel. Press the iPod button on the front panel, iPod indicator will be lit. Click **Play** in the music player software on Apple unit to start playing. Only use Vena to control the volume level, volume control functions on Apple unit will be disabled.

Vena Apple docking is made for:

- iPhone 5
- iPhone 4S
- iPhone 4
- iPad (4th generation)
- iPad mini
- iPad (3rd generation)
- iPad 2
- iPod touch (5th generation)
- iPod touch (4th generation)
- iPod touch (3rd generation)
- iPod nano (7th generation)
- iPod nano (6th generation)
- Made for iPod nano (5th generation)



Note: Models not listed here may be supported by Vena despite not having undergone compatibility testing. iPhone, iPad and iPod models will charge their battery continuously when docked if Vena is connected to mains power.

"Made for iPhone", "Made for iPad" and "Made for iPod" mean that an electronic accessory has been designed to connect specifically to iPhone, iPad or iPod, respectively, and has been certified by the developer to meet Apple performance standards. Apple is not responsible for the operation of this device or its compliance with safety and regulatory standards. Please note that the use of this accessory with iPhone, iPad or iPod may or may not affect wireless performance.

Playing Music via Bluetooth

You can wirelessly connect Vena to a music source via Bluetooth wireless technology. Volume up/down, standby and mute in/out can be controlled from either your Bluetooth source or from Vena. Other functions – play, pause, previous track, next track, fast forward and reverse are all controlled from your Bluetooth source only.

Establishing a Bluetooth Connection

1. Place Vena and a Bluetooth music source within a few meters of each other.
2. Power on Vena and select Bluetooth as the source. The Bluetooth source indicator will flash twice when in pairing mode.
3. Activate the Bluetooth function on your music source.
4. Select "Quad Vena" when Vena is found to start the pairing process.
5. If prompted for a password, enter "0000".

To play music

Select Vena as a music output device on your Bluetooth source to start playing music.

Disconnecting Bluetooth Connection

To disconnect the Bluetooth music source either:

- Move the Bluetooth source beyond the communication area.
- Turn off the connected device or turn off its Bluetooth function.

Note:

If you have difficulty connecting Vena to a Bluetooth device, please try selecting "Forget this Device" on your source unit and then go through the connection procedure again.

SPECIFICATIONS

(All measurement made with 230V supply)

D/A Converter	Crystal CS4398 24 bit DAC
Input Sampling Rates	44.1-192kHz
Rated Output Power	2 x 45W (8Ω)
Total Harmonic Distortion	≤0.009% (10W 1kHz)
Frequency Response	-0.5dB 20Hz-30kHz (ref. 1kHz)
Input Sensitivity	450mV (RCA AUX in)
Input Impedance	10kΩ (Unbalanced)
Signal to Noise Ratio (S/N)	≥108dB (A Weighted, ref. 45W)
Pre Output Level	2.3V (Max)
Bluetooth Version	3.0
Profile	A2DP
Codec	aptX (priority), SBC
Apple Docking Input	1 x USB (A-type)
USB Input	1 x USB (B-type)
USB Input Sampling Rates	44.1kHz, 48kHz, 88.2kHz, 96kHz, 176.4kHz, 192kHz
Digital Audio Inputs	2 x Optical TOSlink 1 x RCA Coax
Digital Audio Outputs	1 x Optical TOSlink 1 x RCA Coax
Analog Inputs	2 x RCA (AUX1, AUX2)
Power Requirement	220-230V~50/60Hz 110-120V 50/60Hz 100V 50/60Hz
Dimensions (WxHxD)	313 x 93.5 x 302 (mm)
Metal Enclosure	6.1kg
Wood Cabinet	7.5kg

CARE AND CLEANING

While cleaning is in progress the AC power cord must be unplugged from the AC power supply socket.

The surface of the equipment should be cleaned with a damp soft cloth. Solvent based cleaning materials should not be used as they may damage the finish.

If you have any queries regarding the use of QUAD equipment, consult your dealer.

WARRANTY

QUAD equipment is guaranteed against any defect in material and workmanship for a period of one year from the date of purchase. Proof of purchase is required for warranty claims.

Please complete and return the enclosed Warranty Registration Form. Within the warranty period QUAD will undertake replacement of defective parts free of charge provided that the failure was not caused by misuse, accident or negligence. Your statutory rights within the territory in which you purchased the equipment is not affected by this warranty.

QUAD carries out regular reviews and reserves the right to adjust the specifications and performance from time to time.

SERVICING

Product service enquiries should, in the first instance, be referred to the supplying dealer. If you need to return your equipment for servicing we recommend that it is shipped in its original packing.

In cases of difficulty or for other product enquiries please contact the appointed QUAD distributor for your country. Principal Service Centre addresses and contact numbers can be found below.

For information of worldwide authorized service centres, please read worldwide distributor list on the QUAD website: www.quad-hifi.co.uk.

INTERNATIONAL SERVICE CENTRE ADDRESS

IAG House
13/14 Glebe Road
Huntingdon
Cambridgeshire
PE29 7DL
UK
Tel: 01480 452561
Fax: 01480 413403



IAG-QUAD

Correct Disposal of this product. This marking indicates that this product should not be disposed with other household wastes throughout the EU. To prevent possible harm to the environment or human health from uncontrolled waste disposal, recycle it responsibly to promote the sustainable reuse of material resources. To return your used device, please use the return and collection systems or contact the retailer where the product was purchased. They can take this product for environmental safe recycling.

QUAD

IAG House, 13/14 Glebe Road, Huntingdon, Cambridgeshire, PE29 7DL, UK

Tel: +44(0)1480 452561 Fax: +44(0)1480 413403 <http://www.quad-hifi.co.uk>

IAG reserves the right to alter the design and specifications without notice. All rights reserved © IAG Group Ltd.

Quad is a member of the International Audio Group. Code: QH13-MNL001a