

ROTEL®

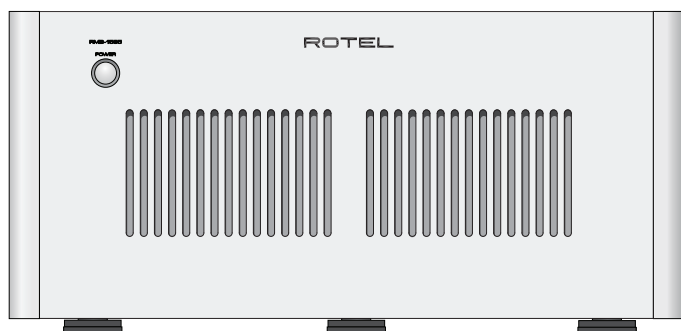
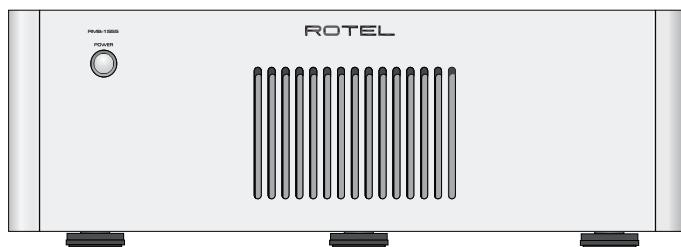

RMB-1555 / RMB-1585

Five Channel Power Amplifiers

Owner's Manual



**AVAILABLE AT
DIGITAL CINEMA**

Important Safety Instructions

WARNING: There are no user serviceable parts inside. Refer all servicing to qualified service personnel.

WARNING: To reduce the risk of fire or electric shock, do not expose the unit to moisture or water. Do not expose the unit to dripping or splashing. Do not place objects filled with liquids, such as vases, on the unit. Do not allow foreign objects to get into the enclosure. If the unit is exposed to moisture, or a foreign object gets into the enclosure, immediately disconnect the power cord from the wall. Take the unit to a qualified service person for inspection and necessary repairs.

Read all the instructions before connecting or operating the component.

Keep this manual so you can refer to these safety instructions.

Heed all warnings and safety information in these instructions and on the product itself. Follow all operating instructions.

Clean the enclosure only with a dry cloth or a vacuum cleaner.

Do not use this unit near water.

You must allow a minimum 10 cm or 4 inches of unobstructed clearance around the unit.

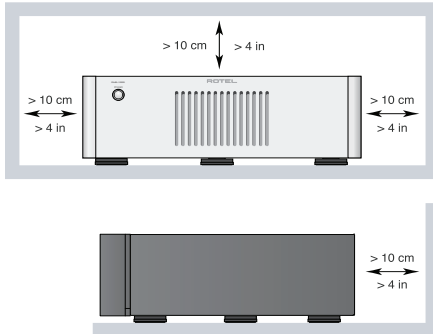

Do not place the unit on a bed, sofa, rug, or similar surface that could block the ventilation openings. If the unit is placed in a bookcase or cabinet, there must be ventilation of the cabinet to allow proper cooling.

Keep the component away from radiators, heat registers, stoves, or any other appliance that produces heat.

WARNING: The rear panel power cord connector is the mains power disconnect device. The device must be located in an open area that allows access to the cord connector.

The unit must be connected to a power supply only of the type and voltage specified on the rear panel. (USA: 120 V/60Hz, EC: 230V/50Hz)

Connect the component to the power outlet only with the supplied power supply cable or an exact equivalent. Do not modify the supplied cable. A polarized plug has two blades, with one wider than the other. A grounding plug has two blades plus a third grounding prong. These are provided for your safety. Do not defeat grounding and/or polarization safety provisions. If the supplied plug does not fit your outlet, please consult an electrician for replacement of the obsolete outlet. Do not use extension cords.

The main plug of the power cordset is a disconnect device of the apparatus. In order to completely disconnect the apparatus from the supply mains, the main plug of the power cordset should be unplugged from the mains (AC) outlet. The stand-by LED indicator will not be lit up to show the power cord is unplugged. The disconnect device shall remain readily operable.

Do not route the power cord where it will be crushed, pinched, bent, exposed to heat, or damaged in any way. Pay particular attention to the power cord at the plug and where the cord exits the back of the unit.

The power cord should be unplugged from the wall outlet during a lightning storm or if the unit is to be left unused for a long period of time.

This apparatus shall be connected to a main socket outlet with a protective earth connection.

Use only accessories specified by the manufacturer.

Use only with a cart, stand, rack, bracket or shelf system recommended by Rotel. Use caution when moving the unit in a stand or rack to avoid injury from a tip-over.



Use Class 2 wiring for speaker connections to ensure proper insulation and minimize the risk of electric shock.

Immediately stop using the component and have it inspected and/or serviced by a qualified service agency if:

- The power supply cord or plug has been damaged
- Objects have fallen or liquid has been spilled into the unit
- The unit has been exposed to rain
- The unit shows signs of improper operation
- The unit has been dropped or damaged in any way

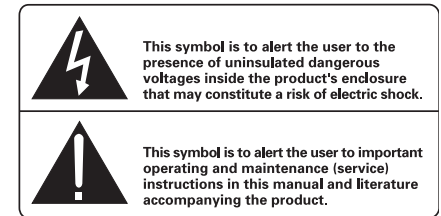
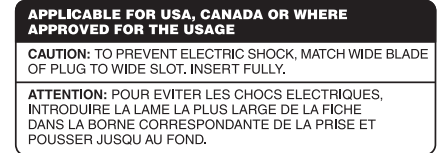

Rotel products are designed to comply with international directives on the Restriction of Hazardous Substances (RoHS) in electrical and electronic equipment and the disposal of Waste Electrical and Electronic Equipment (WEEE). The crossed wheeled bin symbol indicates compliance and that the products must be appropriately recycled or processed in accordance with these directives.

Pin Assignments

Balanced Audio (3 pole XLR):

Pin 1: Ground / Screen

Pin 2: In phase / +ve / Hot

Pin 3: Out of phase / -ve / Cold

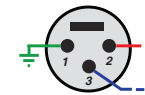

Figure 1-1: RMB-1555 Controls and Connections
 Commandes et Branchements RMB-1555
 RMB-1555 Bedienelemente und Anschlüsse
 Controles y Conexiones de la RMB-1555

RMB-1555 Bedieningselementen en aansluitingen
 RMB-1555 Controlli e connessioni
 RMB-1555: Kontrollier och anslutningar
 Органы управления и разъемы RMB-1555

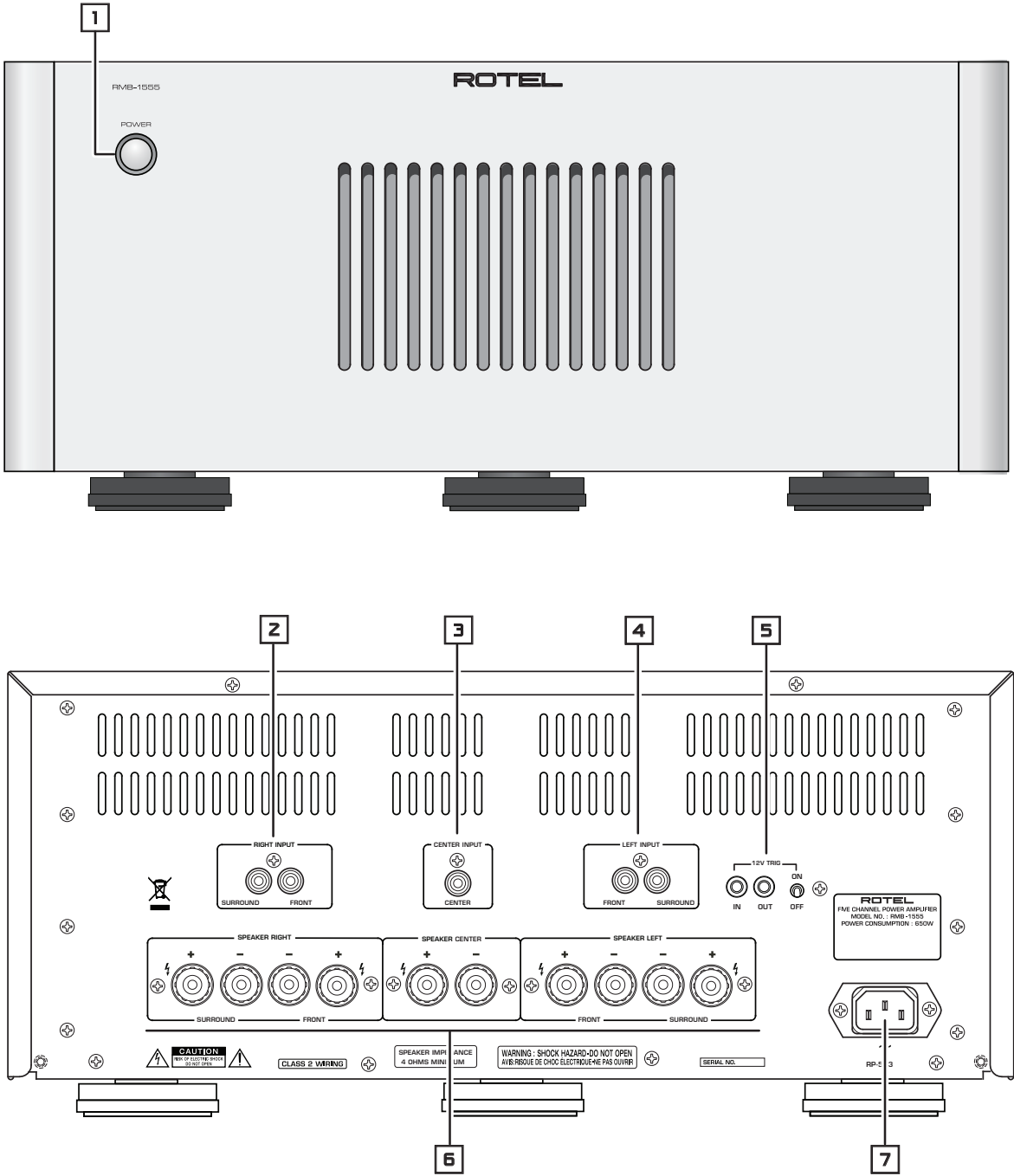

Figure 1-2: RMB-1585 Controls and Connections
 Commandes et Branchements RMB-1585
 RMB-1585 Bedienelemente und Anschlüsse
 Controles y Conexiones de la RMB-1585

RMB-1585 Bedieningselementen en aansluitingen
 RMB-1585 Controlli e connessioni
 RMB-1585: Kontrollor och anslutningar
 Органы управления и разъемы RMB-1585

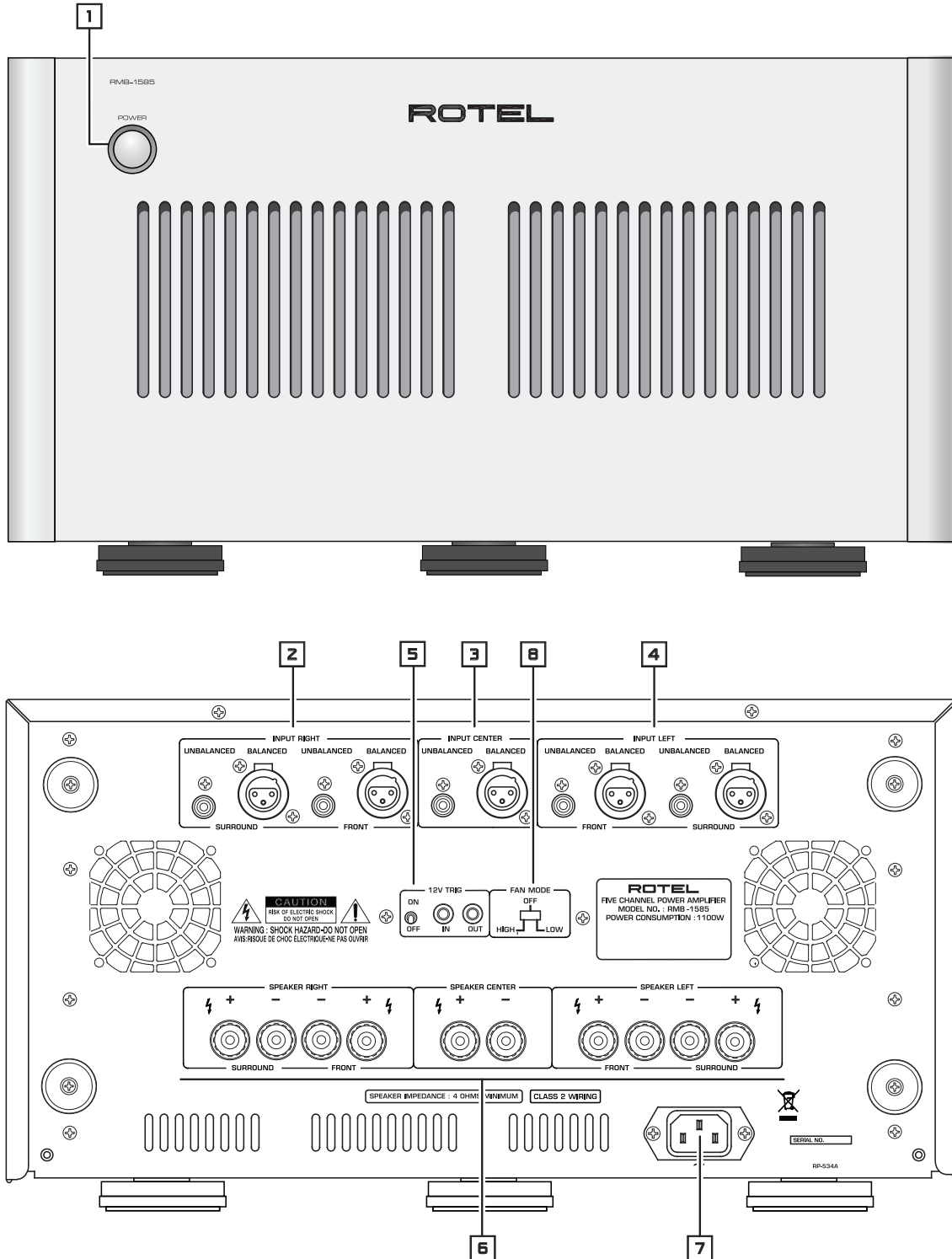

Figure 2: Analog Inputs and Speaker Output Connections
 Branchements des entrées analogiques et sorties enceintes acoustiques
 Analoge Eingänge und Anschließen der Lautsprecher
 Entradas Analógicas y Conexiones de Salida a las Cajas Acústicas

Analoge ingangen en luidsprekeruitgangen
 Collegamenti ingressi analogici ed uscite diffusori
 Analoga ingångar och högtalaranslutningar
 Аналоговые входы и выходы на колонки

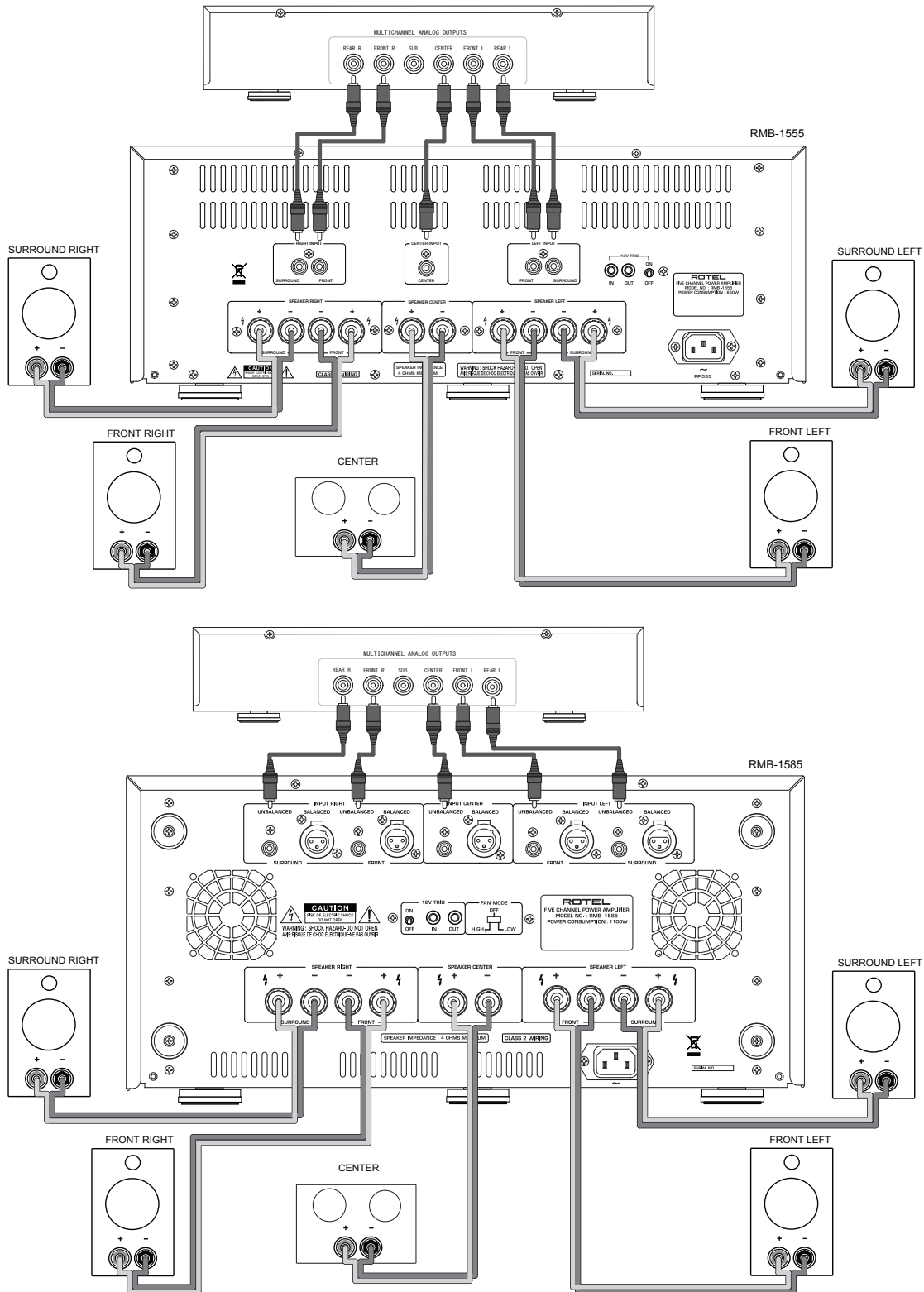
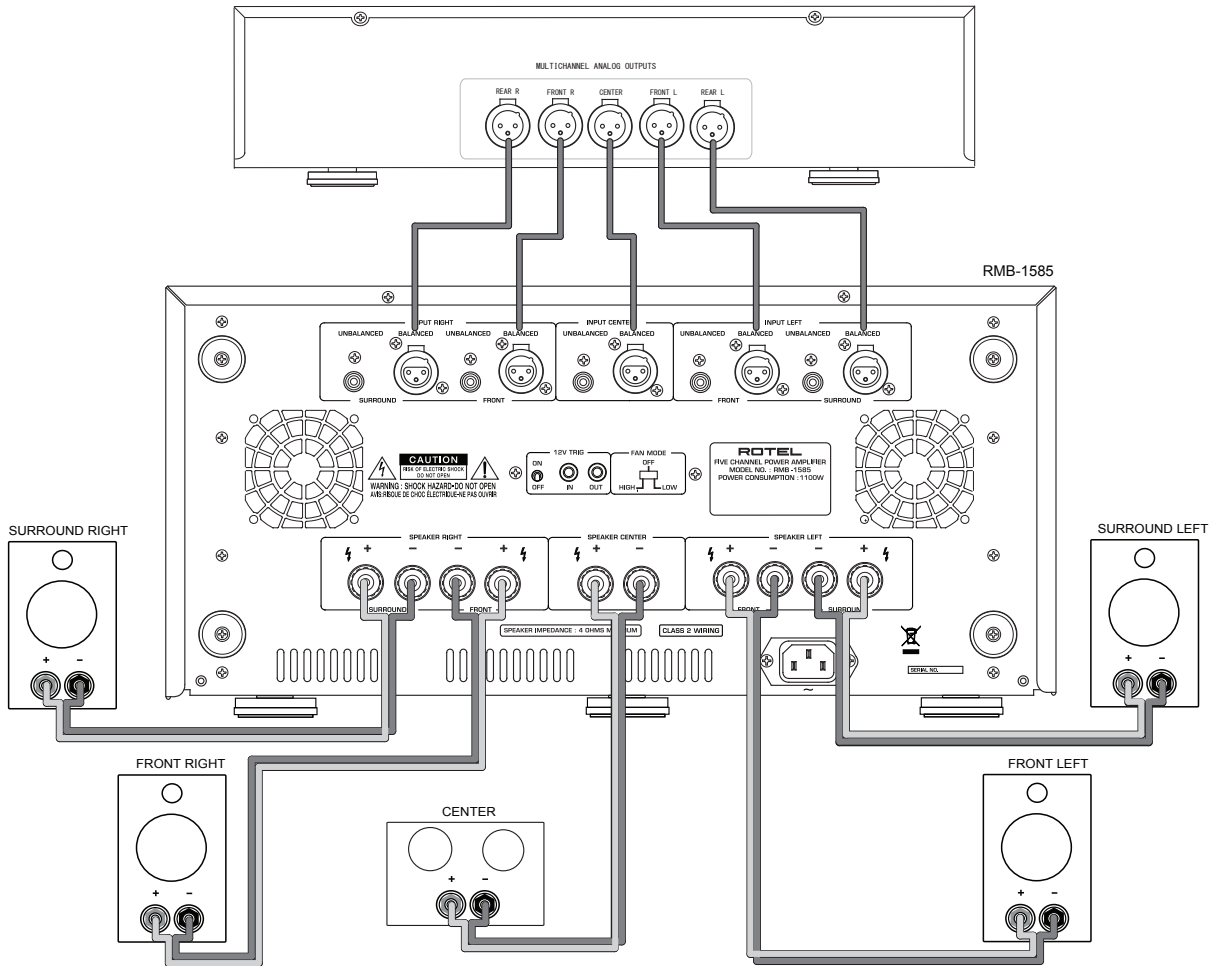











Figure 3: Balanced (XLR) Inputs
 Branchements des entrées symétriques (XLR)
 Symmetrische (XLR) Eingänge
 Entradas Balanceadas (XLR)

Gebalanceerde ingangen (XLR)
 Ingressi analogici bilanciati (XLR)
 Balanserade ingångar (XLR)
 Балансные (XLR) входы



Contents

Important Safety Instructions	2
Figure 1-1: RMB-1555 Controls and Connections	3
Figure 1-2: RMB-1585 Controls and Connections	4
Figure 2: Analog Inputs and Speaker Output Connections	5
Figure 3: Balanced (XLR) Inputs	6
Important Notes	7
About Rotel	8
A Word About Watts	8
Getting Started	8
A Few Precautions	9
Placement	9
AC Power and Control	9
AC Power Input 	9
Power Switch and Power Indicator 	9
Trigger ON/OFF Mode Selector 	9
12 Volt Trigger Input and Output 	9
Protection Circuitry 	9
Input Signal Connection   	10
Speaker Connection	10
Speaker Selection	10
Speaker Wire Selection	10
Polarity and Phasing	10
Speaker Connection 	10
Cooling Fans	10
Troubleshooting	11
Power Indicator Is Not Illuminated-	11
Fuse Replacement	11
No Sound	11
Pretection Indicator	11
Specifications	11

About Rotel

Our story began over 50 years ago. Over the decades, we have received hundreds of awards for our products and satisfied hundreds of thousands of people who take their entertainment seriously - like you!

Rotel was founded by a family whose passionate interest in music led them to manufacture high-fidelity components of uncompromising quality. Through the years, that passion has remained undiminished and the family goal of providing exceptional value for audiophiles and music lovers, regardless of their budget, is shared by all Rotel employees.

Rotel's engineers work as a close team, listening to, and fine tuning, each new product until it reaches their exacting musical standards. They are free to choose components from around the world in order to make that product the best they can. You are likely to find capacitors from the United Kingdom and Germany, semiconductors from Japan or the United States, while toroidal power transformers are manufactured in Rotel's own factory.

We all have concerns about our environment. And, as more and more electronics are produced and later discarded, it is especially important for a manufacturer to do all it can to engineer products that have a minimum negative impact on landfill sites and water tables.

At Rotel, we are proud to do our part. We have reduced the lead content in our electronics by using special ROHS solder, while our new Class D (not digital) amplifiers are up to five times more efficient than our legacy designs and still deliver power and performance. These products run cool, give minimum wasted energy, are good for the environment and give better sound too.

Finally, we have printed this brochure on recycled paper stock.

While we understand that these are small first steps, they are still important ones. And we continue to pursue new methods and materials for a cleaner and greener manufacturing process.

All of us at Rotel thank you for buying this product. We are sure it will bring you many years of enjoyment.

A Word About Watts

The RMB-1555 power output is quoted as 120 watts for each channel, and the RMB-1585 power output is quoted as 200 watts for each channel, when five channels are operating together at full power.

Rotel has chosen to specify the power output in this way because, in Rotel's experience, it gives the truest value of the receiver or amplifier's power capability.

When comparing specifications for different products, you should be aware that power output is often specified in other ways, so you may not be comparing like with like. For example, the power output may be quoted with only one channel operating, giving a higher maximum figure.

A loudspeaker's impedance rating indicates the electrical resistance or load it offers when connected to the amplifier, usually 8 ohms or 4 ohms. The lower the impedance, the more power the speaker will need. In effect, a 4 ohm speaker will require twice as much power as an 8 ohm speaker.

However, Rotel amplifiers are designed to work into any speaker impedance between 8 and 4 ohms, and with all the channels working up to their full power. Because the Rotel design is optimized for use with all channels operating together, Rotel is able to specify the true power output for both channels.

This can be important for your enjoyment, too. When watching movies, it's nice to have the amplifier able to reproduce full power into all the channels at the same time, especially in the case of a volcano exploding!

Getting Started

Thank you for purchasing the Rotel RMB-1555 or RMB-1585 Stereo Power Amplifier. When used in a high-quality music or home theater system, your Rotel product will provide years of musical enjoyment.

The RMB-1555 and RMB-1585 are high-power amplifiers, providing the highest level of audio performance. Discrete output devices, a massive power supply, premium components, and Rotel's Balanced Design ensure superb sound quality. High current capability allow the RMB-1555 and RMB-1585 to drive the most demanding loudspeakers.

Be aware that the RMB-1555 and RMB-1585 are capable of high power levels, in excess of 120 watts and 200 watts respectively per channel. Make sure that your speakers can handle the power of the amplifier. If in doubt about your speakers, ask your local Rotel audio dealer for advice.

These amplifiers are straightforward in their installation and operation. If you have experience with other stereo power amplifiers, you shouldn't find anything perplexing. Simply plug in the associated components and enjoy.

A Few Precautions

WARNING: To avoid potential damage to your system, turn off ALL the components in the system when connecting or disconnecting the loudspeakers or any associated components. Do not turn the system components back on until you are sure all the connections are correct and secure. Pay particular attention to the speaker wires. There must be no loose strands that could contact the other speaker wires, or the chassis of the amplifier.

Please read this manual carefully. In addition to installation and operating instructions, it provides valuable information on various system configurations as well as general information that will help you get optimum performance from your system. Please contact your authorized Rotel dealer for answers to any questions you might have. In addition, all of us at Rotel welcome your questions and comments.

Save the shipping carton and all enclosed packing material for future use. Shipping or moving the amplifier in anything other than the original packing material may result in severe damage that is not covered by the warranty.

If included in the box please fill out and send in the owner's registration card. Also be sure to keep the original sales receipt. It is your best record of the date of purchase, which you will need in the event warranty service is required.

Placement

The RMB-1555 and RMB-1585 generate heat as part of its normal operation. The heat sinks and ventilation openings in the amplifier are designed to dissipate this heat. The ventilation slots in the top cover must be open. There should be 10 cm (4 inches) of clearance around the chassis, and reasonable airflow through the installation location, to prevent the amplifier from overheating.

Remember the weight of the amplifier when you select an installation location. Make sure that the shelf or cabinet can support it. We recommend installing the unit in furniture designed to house audio components. Such furniture is designed to reduce or suppress vibration which can adversely affect sound quality. Ask your authorized Rotel dealer for advice about component furniture and proper installation of audio components.

AC Power and Control

AC Power Input



Your amplifier is configured at the factory for the proper AC voltage in the country where you purchased it, either 120 volts or 230 volts. The AC line configuration is noted on a decal on the back panel.

NOTE: Should you move your amplifier to another country, it may be possible to reconfigure it for use on a different line voltage. Do not attempt to perform this conversion yourself. Opening the enclosure of the amplifier

exposes you to dangerous voltages. Consult a qualified service person or the Rotel factory service department for information.

NOTE: Some products are intended for sale in more than one country and as such are supplied with more than one AC cord. Please use only the cord appropriate for your country/region.

Because of its high power rating, the amplifier can draw considerable current. Therefore, it should be plugged directly into a wall outlet. The RMB-1555 and RMB-1585 must be plugged into a 3-pin polarized outlet. Do not use an extension cord. A heavy duty multi-tap power outlet strip may be used if it (and the wall outlet) is rated to handle the current demanded by the amplifier and all the other components connected to it.

Be sure the POWER SWITCH  on the front panel of the amplifier is turned off (in the "out" position). Then, connect the supplied power cord to the Power Connector  on the rear of the unit and the AC power outlet.

If you are going to be away from home for an extended period of time such as a month-long vacation, it is a sensible precaution to unplug your amplifier (as well as other audio and video components) while you are away.

Power Switch and Power Indicator

The power switch is located on the front panel of your amplifier. To turn the amplifier on, push the switch in. The ring around the switch will light up, indicating that the amplifier is turned on. To turn the amplifier off, push the button again and return it to the "out" position.

NOTE: Place the self adhesive ring over the light surrounding the Power switch if the blue light is too bright.

Trigger ON/OFF Mode Selector

The amplifier provides the option for manual or automatic power on/off operation. These modes are selectable using a toggle switch on the back panel.

With the switch in the +12V TRIGGER ON position, the amplifier is turned on automatically when a 12V trigger signal is present at the 3.5 mm Jack of TRIGGER IN on the rear panel. The amplifier will go into standby mode if the +12V signal is not present. The front panel POWER SWITCH overrides this function. It must be ON for the +12V trigger to work. Turning the switch OFF cuts power to the amplifier, regardless of whether or not a trigger signal is present.

12 Volt Trigger Input and Output

The jack labeled IN is for connecting the 3.5mm Plug/Cable carrying a +12 volt trigger signal to turn the amplifier on and off. To use this feature the toggle switch must be set to the ON position. This input accepts any control signal (AC or DC) ranging from 3 volts to 30 volts.

The jack labeled OUT is for connecting another 3.5mm plug/cable to provide a 12V trigger signal to other components. The 12V output signal is available whenever a +12 volt trigger signal is applied to the IN connector.

Protection Circuitry

The RMB-1555 and RMB-1585 feature thermal and over-current protection circuits that protect against potential damage in the event of extreme or faulty operating conditions. Unlike many designs, these protection circuits are independent of the audio signal and have no impact on sonic performance. Instead, the protection circuits monitors the temperature of the output devices and the current they are handling and shuts down the amplifier if operating conditions exceed safe limits.

Most likely, you will never see this protection circuitry in action. However, should a faulty condition arise, the amplifier will stop playing and the Power Indicator on the front panel will blink.

If this happens, turn the amplifier off, let it cool down for several minutes, and attempt to identify and correct the problem. When you turn the amplifier back on, the protection circuit will automatically reset and the Power Indicator should light up, indicating that the amplifier is turned on normal.

In most cases, the protection circuitry activates because of a fault condition such as shorted speaker wires, or inadequate ventilation leading to an overheating condition. In very rare cases, highly reactive or extremely low impedance speaker loads could cause the protection circuit to engage.

If the protection circuitry triggers repeatedly and you are unable to isolate and correct the faulty condition, contact your authorized Rotel dealer for assistance in troubleshooting.

Input Signal Connections 2 3 4

The RMB-1555 and RMB-1585 have conventional RCA type input connectors, the type found on nearly all audio equipment. The RMB-1585 also includes Balanced input connectors. Only one set of inputs should be connected. Never connected both Balanced and RCA inputs at the same time.

NOTE: To prevent loud potentially damaging noises, make sure the amplifier is turned off when you make any changes to the input signal configuration.

Select high quality audio interconnect cables. Connect each of the outputs from the preamplifier or signal processor to the corresponding input of the amplifier.

Speaker Connection

Speaker Selection

We recommend using loudspeakers with a nominal impedance of 4 ohms or higher with the RMB-1555 and RMB-1585. You should exercise some caution in driving multiple pairs of speakers in parallel configuration, because the effective impedance the amplifier sees is cut in half. For example, when driving two pair of 8 ohm speakers, the amplifier sees a 4 ohm load. When driving multiple speakers in parallel, it is recommended that you select speakers with a nominal impedance of 8 ohms or higher. Speaker impedance ratings are less than precise. In practice, very few loudspeakers will present any problems for the RMB-1555 or RMB-1585. See your authorized Rotel dealer if you have any questions.

Speaker Wire Selection

Use insulated two-conductor stranded wire to connect the amplifier to the speakers. The size and quality of the wire can have an audible effect on the performance of the system. Standard speaker wire will work, but can result in lower output or diminished bass response, particularly over longer distances. In general, heavier wire will improve the sound. For best performance, you may want to consider special high-quality speaker cables. Your authorized Rotel dealer can help in the selection of cables for your system.

Polarity and Phasing

The polarity – the positive/negative orientation of the connections – for every speaker and amplifier connection must be consistent so all the speakers will be in phase. If the polarity of one connection is reversed, bass output will be very weak and stereo imaging degraded. All wire is marked so you can identify the two conductors. There may be ribs or a stripe on the insulation of one conductor. The wire may have clear insulation with different color conductors (copper and silver). There may be polarity indications printed on the insulation. Identify the positive and negative conductors and be consistent with every speaker and amplifier connection.

Speaker Connections 5

NOTE: The following text describes both binding post and plug-in connections. DO NOT use both connection methods in combination to connect multiple speakers.

Turn off all the components in the system before connecting the speakers. The RMB-1555 and RMB-1585 have two color coded binding posts, two for each channel. These connectors accept bare wire, connector lugs, or dual banana type connectors (except in the European Community countries where their use is not permitted).

Route the wire from the amplifier to the speakers. Give yourself enough slack so you can move the components to allow access to the speaker connectors.

If you are using dual banana plugs, connect them to the wires and then plug into the backs of the binding posts. The thumbscrews of the binding posts should be screwed in all the way (clockwise).

If you are using terminal lugs, connect them to the wires. If you are attaching bare wires directly to the binding posts, separate the wire conductors and strip the insulation from the end of each conductor. Be careful not to cut into the wire strands. Unscrew (turn counterclockwise) the binding post. Place the connector lug or wire around the binding post shaft. Turn the binding post clockwise to clamp the connector lug or wire firmly in place.

NOTE: Be sure there are no loose wire strands that could touch adjacent wires or connectors.

Cooling Fans

The Rotel RMB-1585 amplifier is equipped with dual cooling fans to help ventilate the internal components. The rear panel of the RMB-1585 includes a 3 position fan speed selection switch including **Fan Off**, **Fan Low Speed** and **Fan High Speed**. Please select the fan speed that best suits the installation and cooling requirements considering that higher speed fan will provide more cooling.

NOTE: The RMB-1585 produces significant power and associated heat - even with the cooling fans in use. Appropriate installation and ventilation is required to ensure proper operation.

Troubleshooting

Most difficulties in audio systems are the result of incorrect connections, or improper control settings. If you encounter problems, isolate the area of the difficulty, check the control settings, determine the cause of the fault and make the necessary changes. If you are unable to get sound from the amplifier, refer to the suggestions for the following conditions:

Power Indicator Is Not Illuminated

No main power to the amplifier. Check the front panel power switch. Make sure that it is set to the on position. Check AC power connections at the amplifier and the AC outlet.

Fuse Replacement

If another electrical device works when plugged into the power outlet, but the Power Indicator of the unit does not light when plugged into the same outlet and the Power Switch is pushed in, it indicates that the internal power fuse may have blown. If you believe this has happened, contact your authorized Rotel dealer to get the fuse replaced.

No Sound

If the amp is getting AC power, but is producing no sound, check the Protection indicator on the front panel. If it is lit, see below. If not, check all of your connections and control settings on associated components.

Protection Indicator

The front panel POWER indicator is blinking when the amplifier protection circuits have shut off the amplifier. Typically, this occurs only when the ventilation openings are blocked, when there is faulty speaker wiring, or after a period of extreme use. Turn off the system and wait for the amp to cool. Then push the front panel power switch in and out to reset the protection devices. If the problem is not corrected or reoccurs, there is a problem with the system or the amplifier itself.

Specifications

RMB-1555

Continuous Power Output <i>(20-20kHz, < 0.03%, 8 ohms)</i>	120 watts/channel, 5 channels driven
Total Harmonic Distortion <i>(20Hz-20kHz, 8 ohms)</i>	< 0.03%
Intermodulation Distortion (60Hz : 7kHz, 4:1)	< 0.03%
Frequency Response (+0.5, -3dB)	10Hz - 100kHz
Damping Factor (20-20kHz, 8 ohms)	180
Speaker Impedance	4 ohms minimum
Signal to Noise Ratio (IHF A network)	116 dB
Input Impedance/Sensitivity	12k Ohms/1.5 volt
Gain	26.5 dB
Power Requirements	
U.S. version	120 Volts, 60Hz
European version	230 Volts, 50Hz
Power Consumption	650 Watts
Dimensions	
Width x Height x Depth	431 x 188 x 454 mm 17 x 7 ¹ / ₂ x 17 ⁷ / ₈ ins.
Front Panel Height	4U / 176.8mm / 7 ins.
Weight (net)	21.8kg / 48.1 lbs.

RMB-1585

Continuous Power Output <i>(20-20kHz, < 0.03%, 8 ohms)</i>	200 watts/channel, 5 channel driven
Total Harmonic Distortion <i>(20Hz-20kHz, 8 ohms)</i>	< 0.03%
Intermodulation Distortion (60 Hz : 7 kHz, 4:1)	< 0.03%
Frequency Response (+0.5, -3dB)	10Hz - 100kHz
Damping Factor (20-20kHz, 8 ohms)	260
Speaker Impedance	4 ohms minimum
Signal to Noise Ratio (IHF A network)	116 dB
Input Impedance/Sensitivity	
Unbalanced	12k Ohms/1.9 volt
Balanced	100k Ohms/3.8 volt
Gain	26.5 dB
Power Requirements	
U.S. version	120 Volts, 60Hz
European version	230 Volts, 50Hz
Power Consumption	1100 Watts
Dimensions	
Width x Height x Depth	431 x 237 x 454 mm 17 x 9 ³ / ₈ x 17 ⁷ / ₈ ins.
Front Panel Height	5U / 221mm / 8 ³ / ₄ ins.
Weight (net)	36kg / 79.3 lbs.

All specifications are accurate at the time of printing.

Rotel reserves the right to make improvements without notice.

Rotel and the Rotel HiFi logo are registered trademarks of The Rotel Co, Ltd., Tokyo, Japan.