

EVO4 Series

EVO 4.1
EVO 4.2
EVO 4.3
EVO 4.4
EVO 4.C
EVO 4.CS
EVO 4.S

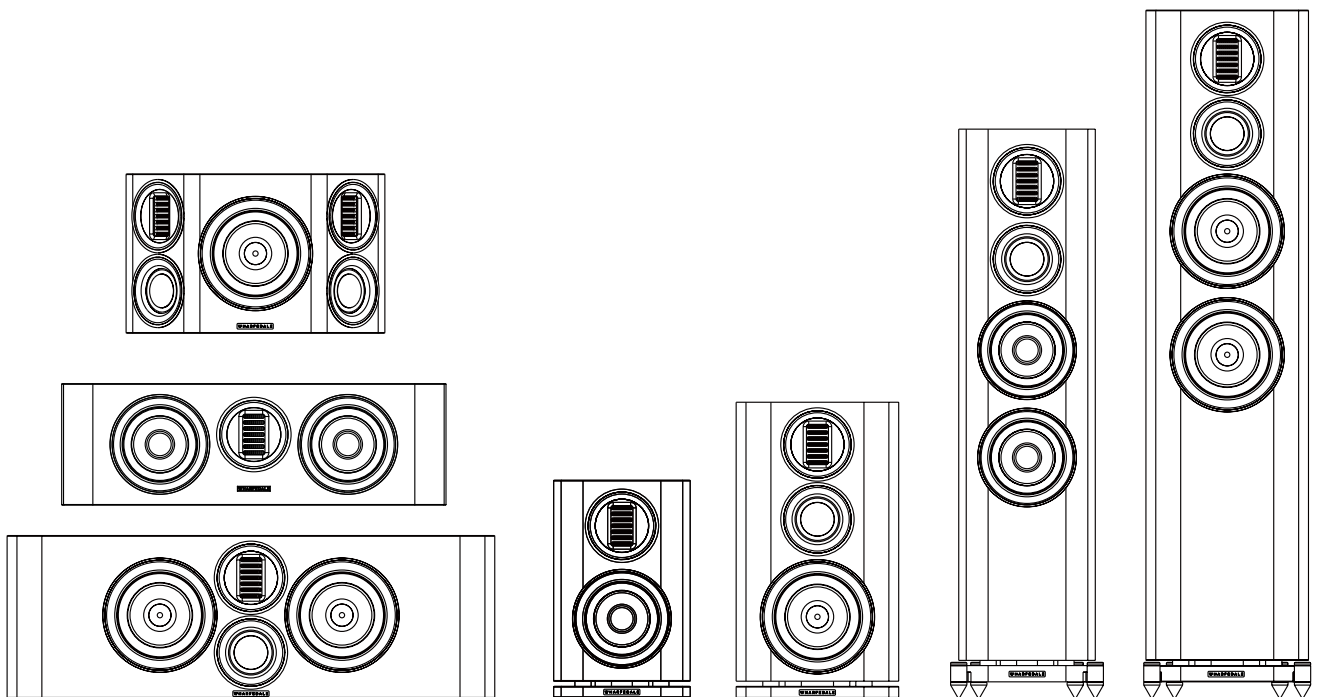

Important Safety Information

Before installing this product read all these instructions!



This symbol indicates that there are important operating and maintenance instructions in the literature accompanying this unit.

Read these instructions. Keep these instructions. Heed all warnings. Follow all instructions.

Before making any connections, switch all the units in your system off at the mains.

Set the volume control at minimum when you switch on your system or change sources, and turn the level up gradually.

DO NOT use your amplifier at full volume.

Ensure that all loudspeakers in the system are correctly wired.

DO NOT subject your loudspeakers to excessive cold, heat, humidity or sunlight.

Loudspeakers should not be placed directly facing other hi-fi units, or share the same shelf or cabinet.

DO NOT place heavy objects on top of loudspeakers.

Some manufacturers forbid the placing of objects on top of their TV sets. Check your TV handbook before installing the speaker directly on your TV set. Consult your TV dealer if you are in any doubt.

DO NOT connect speaker terminals to the mains supply.

DO NOT dismantle the loudspeaker. There are no user serviceable parts inside it and you will void the warranty by doing so.

Refer all servicing to qualified service personnel. Servicing is required when the apparatus has been damaged in any way, the apparatus has been exposed to rain or moisture, does not operate normally, or has been dropped.

Caution: Changes or modifications not expressly approved by the manufacturer could void the user's authority to operate this device.

Unpacking Your Loudspeaker

EVO4 loudspeakers come in different shapes and sizes. If you are unpacking a floor stander, please remember that these units are heavy. We suggest that you have someone to assist you.

Lift the loudspeaker carefully out of the packing. DO NOT try and lift the loudspeaker using the protective bag.

Unpack the accessories carefully.

If there is any sign of damage or if the contents are incomplete, report this to your dealer as soon as possible.

Retain the packing for future safe transport of the product. If you dispose of the packing, do so with respect to any recycling provisions in your area.

ATTACHING THE SPIKES

CAUTION: SPIKES ARE SHARP.

Make sure that there are no wires or hidden obstacles that could be damaged by the spikes

in the immediate operational area of the speakers.

NEVER drag a loudspeaker on its spikes. always lift it. If the item is heavy get assistance.

A mounting hole is located at each corner of the plinth. Thread a spike through each hole.

Tighten the collar finger tight so that the spike is secure but not locked in place.

After all the spikes are attached, invert the loudspeaker and place it carefully on the floor.

Spike Seats

A set of spike seats is provided to protect sensitive floors from possible damage. The loudspeaker should be mounted on the wide spikes and the spike seats should be placed under each spike as shown.

Level the loudspeakers with the spiker seats in place.

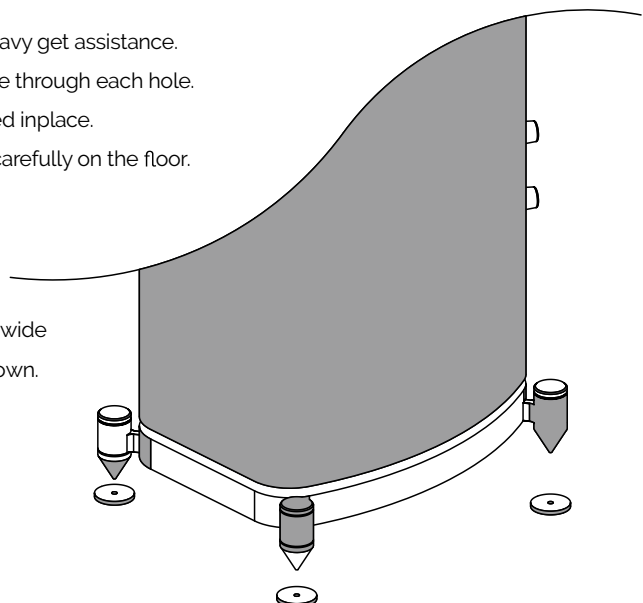

Preparing the EV04 Loudspeakers

Stands and Brackets

The bookshelf loudspeakers are intended primarily for stand mounting, though they can be mounted on wall brackets or even on sturdy shelves. The quality of loudspeaker stands greatly influences the performance of your loudspeakers, please do not use flimsy products.

Centre Channel Loudspeakers

Each centre channel loudspeaker is supplied with one set of mounting feet. By using combination of large and small feet the loudspeaker may be angled to point directly at the listening position. This will be found useful when the centre speaker is positioned under the TV screen.

Cables and Connectors

Choosing Loudspeaker Cable

Specialist audio cable usually offers better performance than general purpose 'bell' or 'zip' wire.

Choose a cable of suitable diameter – cable that is too thin will limit the dynamics of the sound and may impair the bass response. Audio cable is polarised, with two cores of different colours, or often a raised rib or coloured tracer in the case of twin cable. Before you purchase your cable, give careful thought to the positioning of your loudspeakers.

This is especially the case if you are bi-wiring your loudspeakers.

Cable lengths to loudspeaker pairs should be the same for left and right channels in order to equalise the signal transmission. Allow some slack in your speaker cables so you can alter their position to best advantage.

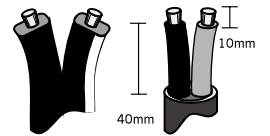

Preparing Loudspeaker Cable

Split the twin cores to a depth of about 40mm. Carefully strip the insulation from each end, leaving about 10mm of bare wire. If the cable is stranded, lightly twist to gather any loose strands.

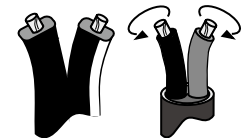

Connecting Screw Terminals

All loudspeakers use screw terminals.

Unscrew the terminal. Insert the bare end of the cable into the hole in the base of the terminal. Tighten securely. When connecting terminals make sure you leave no strands of bare wire that can short across to adjacent terminals.

As an alternative to bare wire you can use specialist spade connectors. Your Wharfedale dealer will be pleased to advise you on this issue.

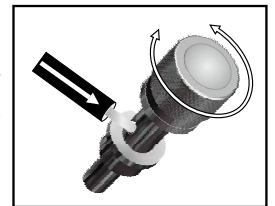

Crossover Networks

Bi-Wireable Networks

If your speakers use a special bi-wireable crossover panel with four terminal binding posts. Please follow the drawing carefully to see the correct orientation of the loudspeaker terminals. The upper terminals connect to the treble unit, the lower pair to the bass unit. As supplied, the treble terminal pair is connected to the bass terminal pair via removable metal straps. These should be left in place for standard installations.

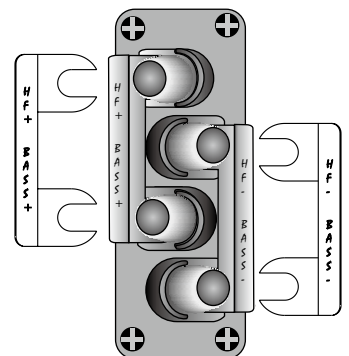

Single Wire Networks

Only for Surround.

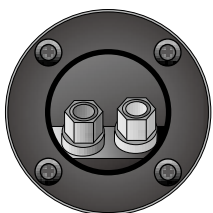

Positioning the Front Loudspeakers

The EVO4.3, EVO4.4 models are designed to be floor standing. We suggest that they are positioned at least 200mm from the rear walls and 700mm from the side walls, facing slightly inwards. The EVO4.1 and EVO4.2 models should be stand or wall mounted though they may be placed on a rigid shelf. The bass extension will improve if the small speakers are operated closer to the rear wall.

If the loudspeakers are placed too close to the walls the bass will increase but may be boomy and indistinct. If the loudspeakers are placed away from the walls, the inward angle may be increased by up to 40%, although this may restrict the width of the optimum listening position.

A useful rule of thumb is that the listener should be as far from the loudspeakers as they are from each other. The speakers should ideally be positioned so that the treble units are roughly at ear level to a seated listener. As personal taste plays a large role, experiment with different configurations and play a wide range of programmes before finalising the position of your speakers.

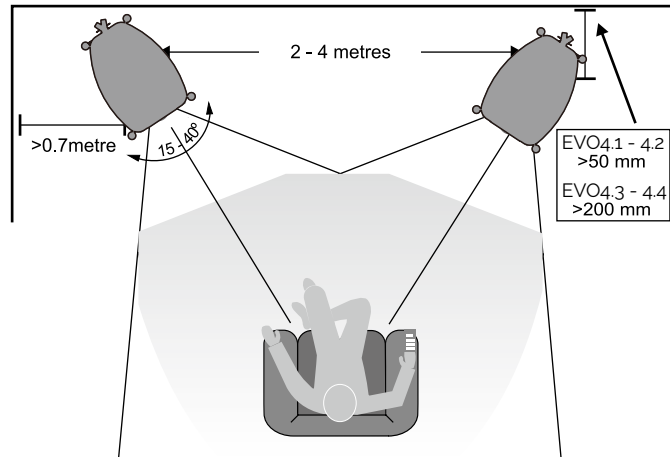

Positioning the Centre Loudspeaker

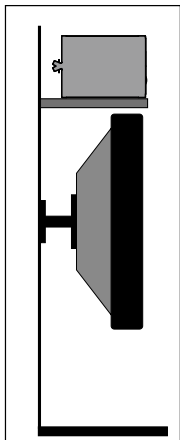

The centre channel loudspeaker should be positioned centrally between the loudspeakers, close to the television and mounted above or below the screen.

The loudspeaker should be located on a stable flat surface to avoid any cabinet movement at high sound levels. If you mount the unit above the television, move it forward so that the front grille sits slightly in front of the screen and the top of the cabinet.

A custom stand is available for the model which allows the loudspeaker to be positioned under a wall mounted monitor and has an adjustable vertical tilt for optimal dispersion.

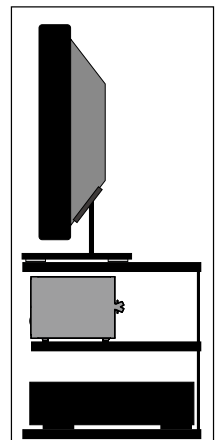

Positioning Surround Loudspeakers

EVO4.S Surround Loudspeakers

The speakers should ideally be sited 600 mm-1.5 metres above the listening position and 2.5-3.5 metres apart, central to the listener and behind the listening position, preferably on a rear wall. If the listening position is some distance from a rear wall, the speakers may be mounted on opposite side walls but always behind the listening position.

Ensure that the wall is sound and can support the product. Drill two 5mm holes in the wall 200mm apart.

Fix a suitable No 8 round head screw firmly into each hole using appropriate wall plugs. Leave a stub of 5mm protruding from the wall.

Connect the loudspeakers. Align the holes in the mounting brackets over the screw and carefully lower the unit onto the screws. The speaker should now be securely attached with the spacers resting against the wall. Now connect the speakers to the amplifier.

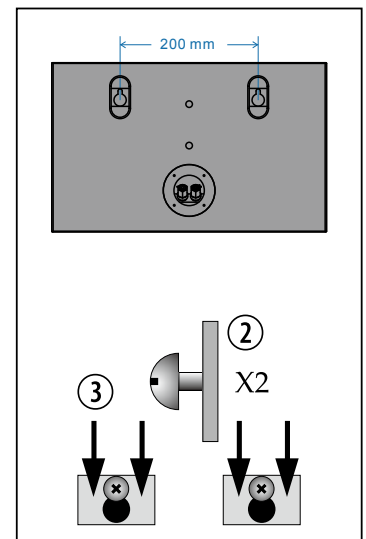

Connecting the Front Loudspeakers

Standard Connection

Choose a suitable length of twin core speaker cable for each channel, and prepare the ends. Unscrew each terminal a few turns.

Connect the red, positive (+) terminal of the Left loudspeaker to the corresponding red, positive (+) amplifier terminal. Connect the black, negative (-) terminals similarly. Tighten the terminals securely. Repeat this procedure for the Right channel.

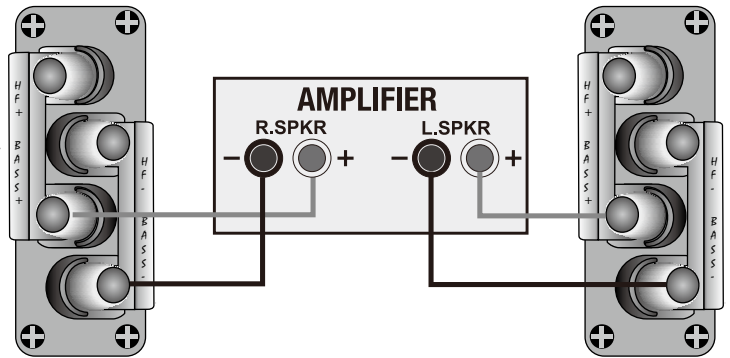

Bi-Wiring

Unscrew each terminal a few turns and remove the metal straps. Connect the cables between the amplifier and the loudspeakers as indicated above and re-tighten all the terminals securely.

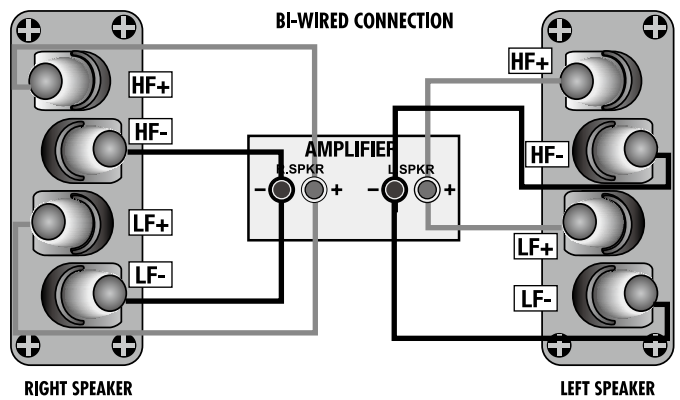

Connecting Centre Loudspeaker

The Centre channel speaker may be connected as shown, or bi-wired.

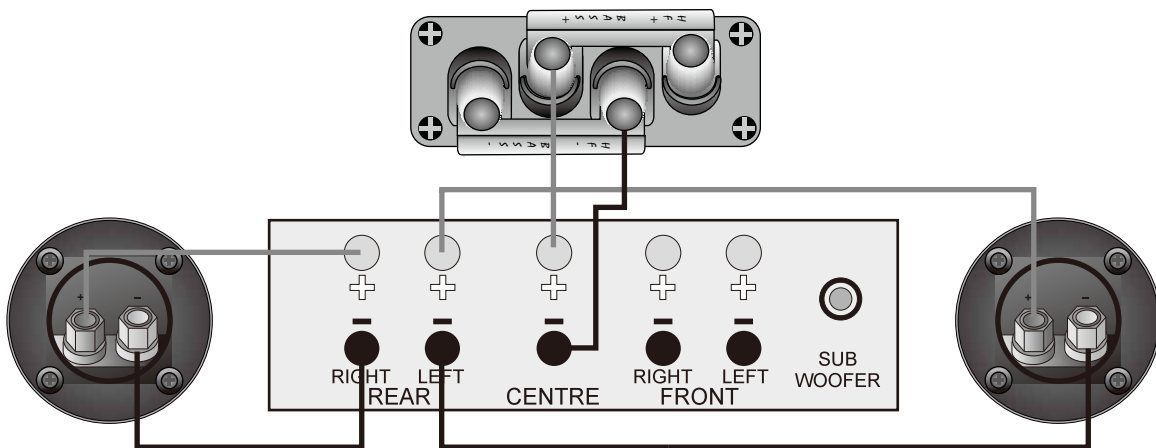

Setting Up a Home Theatre System

Placement

Front and Effects Channels: The front loudspeakers are placed on either side of the television screen, 2 to 3 metres apart. The speakers should be angled slightly so they can aim towards the listeners.

We recommend placing the rear effects speakers in a high position, behind the listener's head. If the rear or side walls are a long way from the listening seat, consider stand mounting the loudspeakers. If the centre loudspeaker is very high or low, angle it towards the listener's ear level.

The front faces of the centre and surround loudspeakers should also be in line as far as possible.

Subwoofer: As the ear is unable to detect the direction from which deep bass originates, you have freedom to position the unit. Varying the distance from the wall alters the bass. Placing the subwoofer across a corner boosts the bass but may impair clarity. The performance of a home theatre system can be enhanced by using two subwoofers.

6.1 and 7.1 System Placement

Dolby Labs, DTS and THX offer 6.1 and 7.1 format. Although the precise configuration of these systems will depend on the capabilities of your processor and you should be guided by those instructions, we would make some observation.

For 6.1 and 7.1 formats the listening seat should not be too close to the rear wall.

Optimising the time delay so that information from all speakers arrives the listening seat coherently is critical of the benefits of these systems are to be fully realised.

Dolby Labs Recommended Placement for Multichannel Home Theater Systems

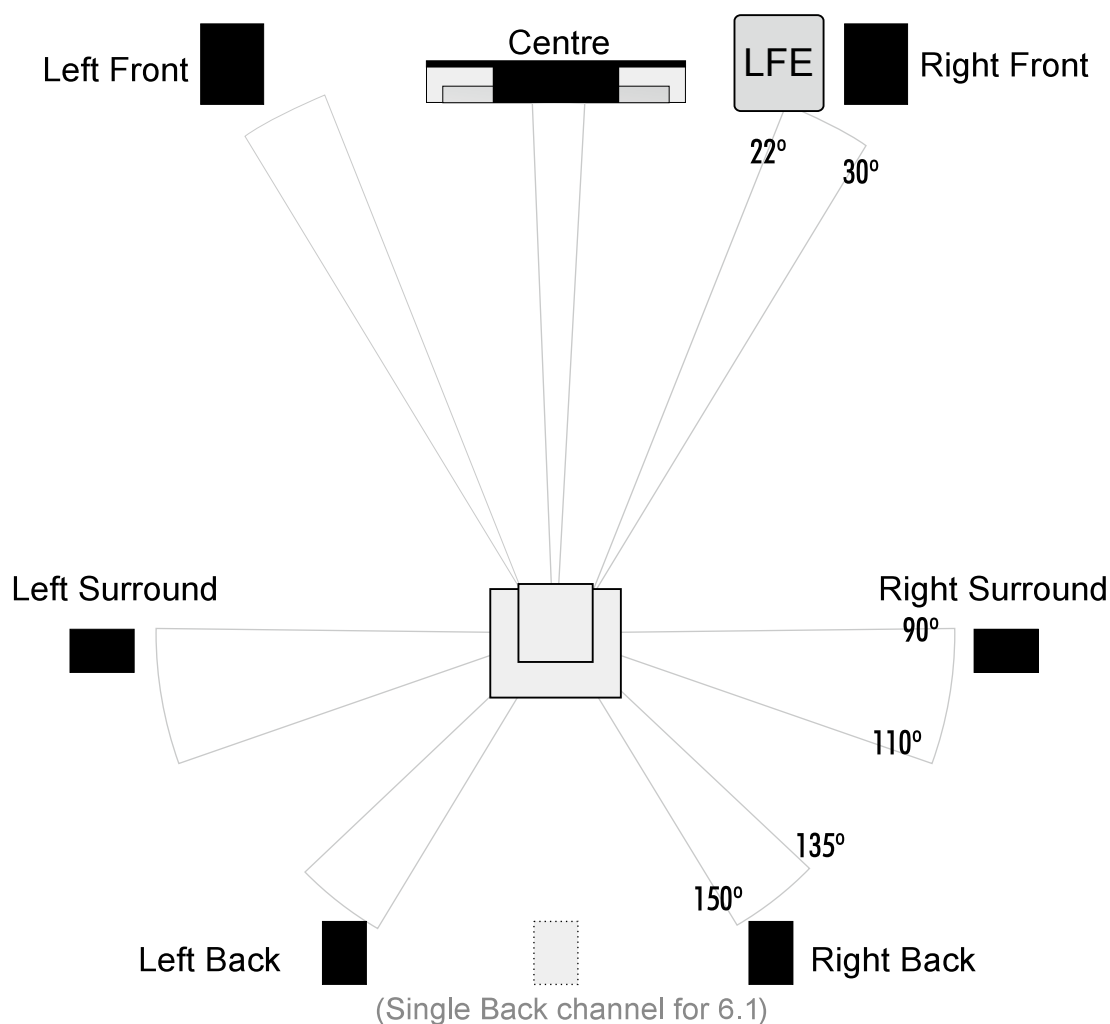

Setting Loudspeaker Sizes and Levels

If you are not using a subwoofer: Set the Front speakers to 'Large'. Set the 'Subwoofer' option on the processor to 'Off' or 'No'. The Front channels will now receive all the system bass.

If you are using a subwoofer: When set to 'Small' all the system bass will go into the subwoofer. If you choose 'Large' the Front channel bass will be reproduced from the Front speakers. Follow the instructions on this page for suitable size and crossover settings.

Once the loudspeaker settings have been finalised, put the A/V amplifier into its 'Test' mode (see instructions supplied with your processor). Adjust the level of each channel until all channels are reproduced at equal loudness.

On some programme material the surround channel may seem lower in level than the front. Do not readjust this level. You may, however, need to adjust the subwoofer output level. Avoid setting too high a level or you will swamp the sound with bass. This can be tiring to listen to, and may limit the subwoofer's ability to respond to large bass transients. You should also set a sensible level going into the subwoofer from the A/V processor. Start with the subwoofer volume control set to between 12 o'clock and 3 o'clock.

Delay and LFE Settings

Many A/V processors feature delay settings. The purpose of delay is to enable surround and dialogue information to arrive at the listener's ears at the same time as the front channels, even when the listening seat is in a non-ideal position. On some processors, this can be achieved by setting the distance from the listening position to each speaker, but other systems allow only a time delay setting.

Rear Delay: If the listening position is equidistant from the front and rear speakers, set a low delay setting. The closer the listener is to the rear speakers this higher the delay setting used should be.

Centre Delay: If the centre speaker is level with (or slightly behind) the front speakers, set the delay to zero. If the centre speaker is forward of the front speakers, increase the delay.

LFE: In the cinema the low frequency effects channel is an extra bass channel with its own subwoofer. In domestic systems the LFE channel typically feeds into the subwoofer. Where no subwoofer is used, the LFE signal is combined with the front channels and sent to the front speakers. When you set the LFE level at your A/V processor, use care as powerful low frequencies can overload domestic loudspeakers. If you hear popping or thumping noises coming from the front loudspeakers or subwoofer, immediately turn the A/V processor's volume level down and then lower the LFE level. This should cure the problem. If it does not, lower the volume level at the subwoofer (if you are using one) until the problem disappears.

Phase: Please read the relevant sections of your A/V amplifier manual and familiarise yourself with the various issues. If you are unsure, consult your dealer for help. A home theatre system should have a precise front stage, a diffuse rear stage and good localization of dialogue. If the colours on the loudspeaker terminals do not correspond with those on the amplifier, the sound will appear poorly focused or 'out of phase'. For this reason it is essential that the speakers are connected according to the wiring diagrams in this manual.

Connecting loudspeakers correctly (in phase) is essential whether the system is stereo or multichannel. This is especially important if you are bi-wiring – if only one element in a bi-wired system is incorrectly connected (out of phase), the effects can be very noticeable yet hard to pinpoint.

Troubleshooting

Before investigating a problem, always switch off the system at mains.

If your system is not working properly please work through this checklist before returning the unit to your dealer.

Symptom	Possible Cause
No Sound	System not switched on; Speaker cables shorting terminals out; Wrong source selected
Sound lacks bass content	Subwoofer not switched on
Lack of bass reproduction	Subwoofer phase incorrect; Subwoofer crossover control too low
Excessive bass distortion at low volumes	Subwoofer set to high; LFE level set too high; Subwoofer incorrectly wired
Excessive or distorted bass at high levels	System level set too high; Bass control set too high; Subwoofer too close to room corners
Distorted / rattling sound at high levels	System level set too high; Objects too close to subwoofer
Popping or thumping from the subwoofer	System level set too high; Subwoofer level set too high; LFE level set too high

Looking After Your Loudspeaker

- This speaker is finished with a luxurious real wood veneer. As with all real wood furniture finishes; exposure to direct sunlight, heat, cold and varying humidity can affect the natural properties of the real wood. We advise protecting the speaker from extreme variances in temperature and environment conditions.
- We advise that you do not place anything on the surface of the cabinets, to protect from damage. Treated with care, the real wood veneers will last a lifetime. They will age naturally and subtly, retaining the properties of the beautiful wood finish.
- Your loudspeakers use a special hardwearing sealed finish. They should not be waxed or treated with spray polishes which will smear and dim the finish. Occasionally polish them with a dry or barely moist cloth to remove dust and finger marks, etc.
- If you play the speakers with the grilles off exercise great care. NEVER operate speakers with the grilles off if there are children or pets in the house.
- Occasionally, remove the loudspeaker grilles and brush them gently with a soft brush before replacing them carefully.
- We advise that you do not use a vacuum cleaner to clean loudspeakers grilles.
- We advise that you do not place anything on your loudspeakers to prevent damage to the cabinet surface.
- Avoid getting any liquid behind the grille. If you spill liquid on your loudspeakers, take them to your dealer for attention before using them again.
- DO NOT open the speakers, there are no user serviceable parts inside.
- NEVER touch the drive units either with an object or your hands.

Quality Assurance

Your loudspeakers have been constructed to the highest standards. From top grade furniture construction and finish to carefully designed and selected acoustic components, Wharfedale speakers are built to provide a lifetime of sonic pleasure. We hope you will derive many years of good service from our products.

Servicing

In the unlikely event that your unit develops a fault you should return it to your Wharfedale dealer using the original packing to ensure safe shipping.

The terms of your guarantee may vary in different countries. However, in all cases the guarantee excludes:

Liability for damage or loss occurring in transit to or from the purchaser.

All damage caused through accident, misuse, wear and tear, neglect, incorrect installation, adjustment or repair by unauthorised personnel.

Wharfedale will not be liable for any consequential damage, loss or injury, arising from or in conjunction with this equipment.

Service Centre Address

For technical support, servicing or product queries and information please contact either your local retailer or the office below.

UK
IAG Service Dept.
13/14 Glebe Road
Huntingdon
Cambridgeshire
PE29 7DL
UK

Tel: +44(0)1480 452561

Eml: service@wharfedale.co.uk

For information on other authorised service centres worldwide contact Wharfedale International, UK.

A world wide distributors list is available on the Wharfedale website: www.wharfedale.co.uk

Specifications

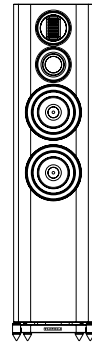
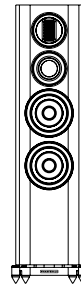
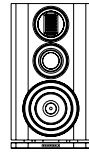
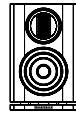

Model	EVO 4.1	EVO 4.2	EVO 4.3	EVO 4.4
General Description	2-way bookshelf speaker	3-way bookshelf speaker	3-way floorstanding speaker	3-way floorstanding speaker
Enclosure Type	bass reflex	bass reflex	bass reflex	bass reflex
Transducer Complement	2-way	3-way	3-way	3-way
Bass Driver	5"(130mm) black woven Kevlar® cone	6.5"(165mm) black woven Kevlar® cone	5"(130mm) black woven Kevlar® cone x2	6.5"(165mm) black woven Kevlar® cone x 2
Midrange Driver	--	2"(50mm) soft dome	2"(50mm) soft dome	2"(50mm) soft dome
Treble Driver	30°60mm AMT	30°60mm AMT	30°60mm AMT	30°60mm AMT
AV Shield	No	No	No	No
Sensitivity (2.83V @ 1M)	87dB	87dB	88dB	89dB
Recommended Amplifier Power	25-100W	25-120W	25-150W	30-200W
Peak SPL	104dB	105dB	105dB	107dB
Nominal Impedance	8Ω compatible	8Ω compatible	8Ω compatible	8Ω compatible
Minimum Impedance	3.5Ω	4.0Ω	4.4Ω	4.3Ω
Frequency Response (+/-3dB)	64Hz ~ 22kHz	54Hz ~ 22kHz	48Hz ~ 22kHz	44Hz ~ 22kHz
Bass Extension (-6dB)	55Hz	48Hz	42Hz	38Hz
Crossover Frequency	2.9kHz	1.4kHz,3.9kHz	1.3kHz,4.3kHz	1.4kHz,4.7kHz
Dimensions (HxWxD)	335 x 210 x (285+10)mm	455 x 250 x (340+10)mm	875 x 210 x (285+10)mm	1060 x 250 x (340+10)mm
Net Weight	7.8kg/pcs	13.4kg/pcs	22.8kg/pcs	25.6kg/pcs

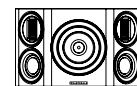
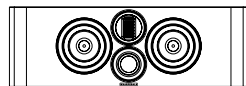

Model	EVO 4.C	EVO 4.CS	EVO 4.S
General Description	3-way centre speaker	2-way centre speaker	3-way surround speaker
Enclosure Type	bass reflex	bass reflex	closed box
Transducer Complement	3-way	2-way	3-way
Bass Driver	6.5"(165mm) black woven Kevlar® cone x 2	5"(130mm) black woven Kevlar® cone x 2	6.5"(165mm) black woven Kevlar® cone
Midrange Driver	2"(50mm) soft dome		2"(50mm) soft dome x 2
Treble Driver	30°60mm AMT	30°60mm AMT	30°60mm AMT x 2
AV Shield	No	No	No
Sensitivity (2.83V @ 1M)	90dB	89dB	88dB
Recommended Amplifier Power	25-150W	25-100W	25-120W
Peak SPL	108dB	103dB	106dB
Nominal Impedance	8Ω compatible	8Ω compatible	8Ω compatible
Minimum Impedance	4.3Ω	4.4Ω	3.9Ω
Frequency Response (+/-3dB)	48Hz ~ 22kHz	50Hz ~ 22kHz	70Hz ~ 22kHz
Bass Extension (-6dB)	42Hz	45Hz	65Hz
Crossover Frequency	1.5kHz,3.9kHz	2.7kHz	1.5kHz, 4.4kHz
Dimensions (HxWxD)	245 x 750 x (340+10)mm	185 x 585 x (265+10)mm	245 x 400 x (145+10)mm
Net Weight	15.8kg/pcs	11.6kg/pcs	11.8kg/pcs

